

#### 【主要諸元】

#### ■クレーン部

名 称	35t吊りラフテレーンクレーン
型 式	KRM-35H-F

#### ●クレーン性能

最大定格総荷重	7.5 mブーム	35,000kg×2.6m (10本掛)
	12.5 mブーム	19,000kg×5.5m (6本掛)
	17.5 mブーム	17,000kg×5.0m (6本掛)
	22.5 mブーム	12,000kg×6.5m (4本掛)
	27.5 mブーム	9,000kg×7.0m (4本掛)
	32.5 mブーム	7,000kg×8.0m (4本掛)
	6.5 mジブ	3,200kg×76° (1本掛)
	10.25 mジブ	2,000kg×71° (1本掛)
14.0 mジブ	1,350kg×76° (1本掛)	
ルースタシブ	4,500kg (1本掛)	
ブーム長さ	7.5m ~ 32.5m	
ジブ長さ	6.5m ~ 14.0m	
最大地上揚程	33.9m (ブーム) 47.9m (ジブ)	
巻上ロープ速度	主巻	125m/min (4層目)
	補巻	125m/min (4層目)
巻上フック速度	主	(ロープ掛数 10) 12.5m / min (4層目)
	補	(ロープ掛数 1) 125.0m / min (4層目)
高速巻下(主・補)	163m / min (4層目)無負荷参考値	
ブーム起伏範囲	-10° ~ 84°	
ブーム上げ時間	44s / -10° ~ 84°	
ブーム伸長速度	25.0m / 85s	
旋回速度	2.5min <sup>-1</sup>	
旋回後端半径	2,850mm	

#### ●上部旋回体の装置および構造

ブーム形式	箱型6段油圧伸縮式 (2・3段同時、4・5・6段同時)	
ジブ形式	3段油圧伸縮式 (2・3段同時) 油圧無段階傾斜式 (オフセット5° (6.5mジブは7°) ~ 60°)	
ブーム伸縮装置	油圧シリンダ (2本) およびワイヤロープ併用式	
ブーム起伏装置	油圧シリンダ直押し、圧力補償付流量調整弁付	
ジブ伸縮装置	油圧シリンダ (1本) およびワイヤロープ併用式	
ジブ起伏装置	油圧シリンダ (2本) シングルウィンチ2基、 油圧モータ駆動・遊星歯車減速機付 (ネガティブブレーキ内蔵)、 高低速切換式、自動ブレーキ付、圧力補償付流量調整弁付	
巻上装置	油圧モータ駆動・遊星歯車減速機付 (ネガティブブレーキ内蔵)、 高低速切換式、自動ブレーキ付、圧力補償付流量調整弁付	
旋回装置	油圧モータ駆動・遊星歯車減速機付 (ネガティブブレーキ内蔵)、フリー・ロック切換式	
旋回サークル	ボールベアリング式	
アウトリガ装置	形式	全油圧H型 (フロント、バーチカルシリンダ一体型)
	張出幅	6,800mm (最大張出)
		6,300mm (中間張出)
		5,200mm (中間張出)
		4,200mm (中間張出)
2,310mm (最小張出)		
ワイヤロープ	主巻	難回転性ワイヤロープ φ16×181m
	補巻	難回転性ワイヤロープ φ16×102m

#### ●油圧装置

油圧ポンプ	2連可変プランジャ型、ギヤ + プランジャ型
油圧モータ	巻上用 アキシャルプランジャ型 旋回用 アキシャルプランジャ型
コントロールバルブ	マルチバルブ自動復元式 (圧力補償付流量調整弁付)
シリンダ	ダブルアクティング式
オイルリザーバ容量	500L

#### ●安全装置

ACS (過負荷防止装置・音声警報装置付)、旋回自動停止装置、ブーム起伏停止装置、 ブーム伸長停止装置、作業範囲制限装置、アウトリガ出庫自動検出装置、 ブーム起伏自然降下防止装置、ブーム伸縮自然降下防止装置、ジブ起伏自然降下防止装置、 ジブ伸縮自然降下防止装置、過巻防止装置、ドラムホルド安全装置、自動ブレーキ装置、乱巻防止装置、 油圧安全弁、アウトリガロック装置、旋回ロック装置、作動油オーバーヒート警報装置、LED旋回警告灯、 作動油フィルタ目詰り警報装置、玉掛けロープはしり止め
---

#### ●標準装置

ドラム回転指示装置、ACS外部表示装置、ACS外部音声警報装置、 拡声器、ウィンチ確認カメラ、LED作業灯 (ブーム、テール、キャブ)
--

#### ●キャブ装備

オートエアコン、チルト/テレスコピックハンドル、 フルアジャスタブル・サスペンションシート (ヘッドレスト、アームレスト付)、 パワーウィンドウ (開閉忘れ防止スイッチ付)、開穴付フロント&ルーアワイパー (ウォッシャー付)、 Bluetooth付AM/FMラジオ、フロアマット、デジタルコグナス、 エントリーキーシステム、クレーン作業記録装置、電子水準器 (自動アウトリガ水平補助機能付)、 LEDルームランプ、LEDステップランプ、アクセサリーソケット (24V)、 USB電源装置・AUXポート
--

#### ●オプション装置

カメラクレーン (ウィンチ確認カメラ用) (注1)、燃費モニター、ドアバイザー、風速計、消火器、 大型ラジエーター、バスフューマック、アッシュトレイ (注1) 左前方確認カメラ・左後方確認カメラ・右後方確認カメラ及び12.1インチタッチモニタ (人検知支援機能付)、セーフティビューシステム装着時のみ装着可。カメラクレーン (セーフティビューカメラ用)、カメラクレーン (前方確認カメラ用) と同時装着。
--

●Bluetooth®はBluetooth SIG, Inc.の登録商標です。

#### ■キャリア部

#### ●走行性能

最高速度	49km / h
登坂能力	0.55 (tanθ)
最小回転半径	8.1m (2輪操向)
	4.9m (4輪操向)

#### ●エンジン

名 称	カミンスQSB6.7-4E (コモンレール式電子制御) (平成26年ディーゼル特殊自動車排出ガス規制適合)
形 式	水冷4サイクル直列6気筒 直接噴射式ディーゼルエンジン
総排気量	6.690L
最高出力	209kW / 2,000 min <sup>-1</sup>
最大トルク	1152N・m / 1,500 min <sup>-1</sup>

#### ●下部走行体の装置および構造

走行駆動形式	2輪駆動 (4×2)、4輪駆動 (4×4) 切換式
トルクコンバータ形式	3要素 1段 (自動ロックアップクラッチ付)
変速機形式	全自動および手動変速式
変速段数	前進4段 後退1段 (Hi/Low切換)

車軸形式	前軸	全浮動式 2段減速機付
	後軸	全浮動式 2段減速機付
懸架装置	前軸	テーパーリフスプリング式 (油圧ロックシリンダ付)
	後軸	テーパーリフスプリング式 (油圧ロックシリンダ付)
ブレーキ装置	主	2系統空気油圧複合式 4輪ディスクブレーキ
ステアリング装置	形式	全油圧式パワーステアリング
	モード	前2輪、カウンタ、クラブ、後2輪、前後輪独立 (5モード) (リヤステ自動ロック機構付)

タイヤサイズ	前輪 385 / 95 R25 170E ROAD 後輪 385 / 95 R25 170E ROAD
--------	--

燃料タンク容量	300L
バッテリー	(12V-120Ah) × 2

#### ●安全装置

緊急停止装置、後方エアリングロック装置、ブレーキ減速警報装置、作業用補助装置、サスペンションロック装置、 オーバーラン警報装置、ラチェット装置警報装置、エアフィルタ目詰り警報装置、ローアワー警報装置、電動機側サイドミラー、 前方確認カメラ、左前方確認カメラ、後方確認カメラ及び12.1インチモニタ、転倒発進補助装置 クリアランスセンサーシステム (左前部、左前部、左後部、右前部及び右後部)、ブーム右側ミラー (ヒータ付)
--

#### ●標準装備

LEDヘッドランプ、オイルクーラ、集中給油装置、アルミ敷板、木製敷板、車輪止め、路肩灯、 LEDサイドマーカランプ (アンダーライト付)
---

#### ●オプション装置

左前方確認カメラ・左後方確認カメラ・右後方確認カメラ及び12.1インチモニタ (人検知支援機能付) (注2)、 セーフティビューシステム (注2)、カメラクレーン (セーフティビューカメラ用) (注3)、 カメラクレーン (前方確認カメラ用) (注3) 無線式後方確認カメラ (注4)、ヒータと電動調整式電動機側サイドミラー、 左前及び右前音声警報装置、タイヤ空気圧モニタリングシステム、アウトリガ乗降アシスト (エンジン常停止アシスト付)、 スタクション (シフト着脱時作業時) (注2) 左前方確認カメラ・後方確認カメラ及び12.1インチモニタ、クリアランスセンサーシステム (左前部、左前部、左後部、右 後部及び右後部) 装着時と異なって同時装着。 (注3) 左前方確認カメラ・左後方確認カメラ・右後方確認カメラ及び12.1インチモニタ (人検知支援機能付)、セーフティ ビューシステム装着時のみ装着可。カメラクレーン (ウィンチ確認カメラ用) と同時装着。 (注4) 左前方確認カメラ、後方確認カメラ及び12.1インチモニタ装着時のみ装着可。
--

#### ■寸法・重量

全長	9,800mm	
全幅	2,620mm	
全高	3,595mm	
軸距	3,650mm	
輪距	前輪	2,170mm
	後輪	2,170mm
乗車定員	1人	
車両総重量	全重量	27,925kg
	前軸重	13,970kg
	後軸重	13,955kg

●本機は、新規開発車両証明制度による適合証明書「基本通行条件 重量：D」の交付を受けていますが、実際の通行条件は、運行経路ごとの道路管理者の算定結果によって付与されます。

#### ■運転および作業に必要な資格

注意事項	クレーンの運転	移動式クレーン運転免許
	玉掛作業	玉掛技能講習
	車両の運転	大型特殊自動車運転免許

- クレーンに関しては、労働安全衛生法が適用されます。
- 所轄の労働基準監督署に設置報告してからお使いください。
- 道路を通行する場合は、車両検査に合格した状態で通行してください。
- 走行時はフックを所定の位置に格納してください。
- 本車両は最低速度 (50km/h) の定めのある「高速自動車国道」を走行することはできません。
- 本機の使用にあたっての注意事項は、取扱説明書をよく読んで正しくお使いください。
- 本カタログに記載されておりませんが性能ならびに仕様は、改良などによりお届いた商品と異なる場合があります。また、仕様は予告なく変更することがありますのであらかじめご了承ください。

## 定格総荷重表注意事項

### ●アウトリガ使用時

1. 定格総荷重表は水平堅土上において機体を水平に設置した状態での保証できる最大荷重を示しており、ブーム作業時は主フックとつり具、ジブ作業時は補フックとつり具の質量を含んだ値です。  
【35tフック(質量310kg)、22tフック(質量225kg)、4.5tフック(質量70kg)】  
□部分は機械の強度によって、他は機体の安定度によって定められています。
2. 作業半径はブーム、ジブのたわみを含んだ実際の値にもとづいていますので、必ず作業半径を基準として作業を行ってください。
3. ジブの作業半径は17.5mまたは32.5mブームにジブを装着して作業を行った場合の値です。  
17.5mをこえ32.5m未満のブーム長さでのジブ作業は、作業半径ではなく32.5mブームの角度を基準としてください。また、17.5m未満のブーム長さでのジブ作業は、作業半径ではなく17.5mブームの角度を基準としてください。
4. アウトリガ最縮小張出では、ジブ作業を行わないでください。
5. アウトリガ張出状態によって側方領域でのつり上性能は異なります。従って各々の張出状態における定格総荷重表で作業を行ってください。また、前方、後方領域でのつり上性能はアウトリガ最大張出の定格総荷重表でそれぞれ作業を行ってください。

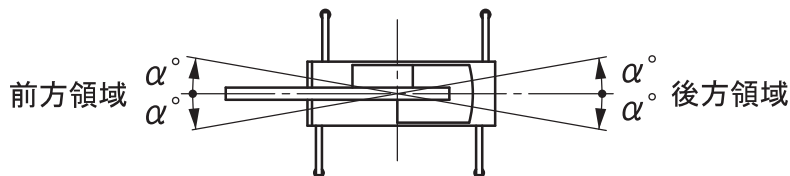

アウトリガ張出状態	中間張出(6.3m)	中間張出(5.2m)	中間張出(4.2m)	最縮小張出
領域 $\alpha^\circ$	30	30	15	3

6. ルースタシーブの定格総荷重は、ブームの定格総荷重よりブームに取付けられているフックその他のつり具の質量を差し引いた値とし、かつ限度を4,500kgとします。  
【ルースタシーブ使用フック:4.5tフック(質量70kg)巻掛本数1】
7. ブーム長さ、ブーム角度、作業半径、ジブ長さ、およびジブ角度が規定の値をこえる場合にはその規定の値と、次の規定の値の定格総荷重のうち小さい方の定格総荷重を目安として作業を行ってください。
8. ジブを装着したままでブーム作業を行う場合の定格総荷重は、ブームの定格総荷重よりフックその他のつり具等の質量の他に3,300kgを差し引いた値とします。なおジブを装着したままでのルースタ作業、およびアウトリガ最縮小張出におけるジブを装着したままでのブーム作業は行わないでください。  
【ジブ装着時使用主フック:22tフック(質量225kg)】
9. 各々の作業状態におけるブーム危険角度は表のとおりです。ブームを危険角度以下にしますと無負荷でも転倒しますので充分注意してください。
10. 各ブーム長さに対する標準フック巻掛本数は表のとおりです。ただし標準巻掛本数以外の掛数で使用する場合は、ワイヤロープ1本当たり37.2kN(3.8tf)を限度としてください。
11. フック巻掛本数10本(定格総荷重表\*印)で作業を行う場合はルースタシーブを使用してください。
12. 高速巻下作業は、フックのみを降下するときに使用してください。また急激なレバー操作はさけてください。
13. クレーン作業は風速10m/sまで可能ですが、比較的弱い風の場合でも受風面積の大きい荷重を取扱う場合は特別な注意を払ってください。
14. 定格総荷重をこえる作業を行った場合、および正しい使い方を行わなかった場合は転倒または破損します。この場合本機の保証はいたしません。

●アウトリガ不使用時

1. 定格総荷重表は、水平堅土上においてタイヤの空気圧が規定圧で、かつサスペンションシリンダを最縮小した場合に本機の保証できる最大荷重を示しており、主フックとつり具の質量を含んだ値です。

□部分は機械の強度によって、他は機体の安定度によって定められています。

【タイヤ規定空気圧：900kPa】

2. 作業半径はブームのたわみを含んだ実際の値にもとづいていますので、必ず作業半径を基準として作業を行ってください。
3. 前方性能と全周性能とは定格総荷重が異なります。前方領域から側方領域へ旋回する場合には、過荷重になるおそれがありますので充分注意してください。

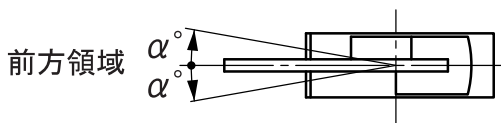

クレーン作業領域 α°	定置つり	走行つり
	1	1

4. ルースタシーブの定格総荷重は、ブームの定格総荷重よりブームに取付けられているフックその他のつり具の質量を差し引いた値とし、かつ限度を4,500kgとします。

【ルースタシーブ使用フック:4.5tフック(質量70kg)巻掛本数1】

5. ブーム長さ22.5mをこえるブーム作業、ジブ作業、高速巻下作業は行わないでください。
6. 定置つり作業はパーキングブレーキを効かせ、同時にブレーキロックを掛けた状態で行ってください。
7. 走行つりはハイ・ロー切換スイッチを“ON”（ローレンジ）、シフトセレクタを1速にして行ってください。
8. 走行つりは荷が振れないように地面近くに保持し、2km/h 未満にて行ってください。  
特にコーナリング、急発進、急制動に注意してください。
9. 走行つり中にはクレーン作業は行わないでください。また、旋回ブレーキを必ず掛けてください。
10. ブーム長さおよび作業半径が規定の値をこえる場合にはその規定の値と、次の規定の値の定格総荷重のうち小さい方の定格総荷重を目安として作業を行ってください。
11. 各々の作業状態における危険角度は表のとおりです。ブームを危険角度以下にしますと無負荷でも転倒しますので充分注意してください。
12. 各ブーム長さに対する標準フック巻掛本数は表のとおりです。  
ただし標準巻掛本数以外の掛数で使用する場合は、ワイヤロープ1本当たり37.2kN(3.8tf)を限度としてください。
13. クレーン作業は風速10m/sまで可能ですが、比較的弱い風の場合でも受風面積の大きい荷重を取扱う場合は特別な注意を払ってください。
14. 定格総荷重をこえる作業を行った場合、および正しい使い方を行わなかった場合は転倒または破損します。  
この場合本機の保証はいたしません。

■作業範囲図

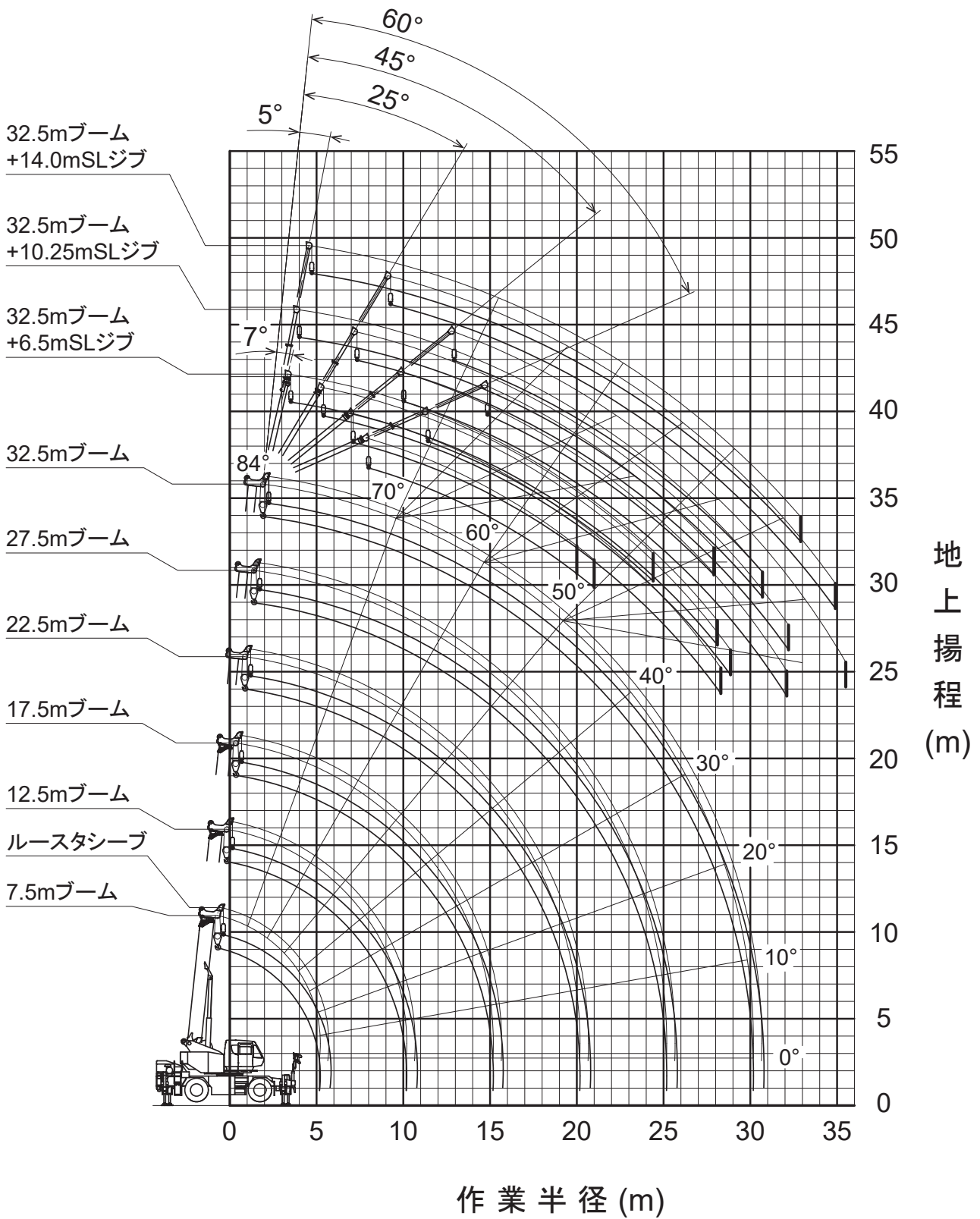

- (注意) 1. 本図はブーム・ジブのたわみを含んでいません。  
 2. 本図はアウトリガ最大張出(全周)のものです。



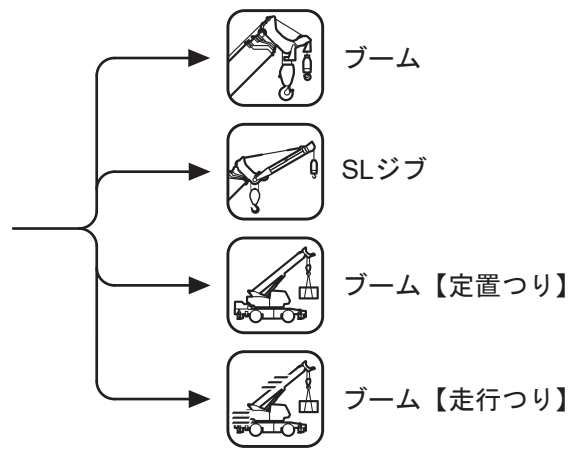
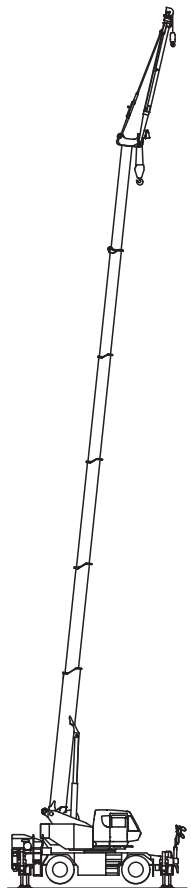



## CITYRANGE MR-350RfII SUPERBOOM ラフター KRM-35H-F (SLジブ)



### 目次



主要諸元	2
定格総荷重表注意事項	3
作業範囲図	5
定格総荷重表	
ブーム【MODE A(通常伸縮)・MODE B(特殊伸縮)】	6
ブーム+SLジブ	11
ブーム【定置つり】	35
ブーム【走行つり】	36
最小通路軌跡図	37
全体図	38
全体図	39







ブーム 	ジブ	アウトリガ  6.8m	作業範囲 
--	----	--	---

 [m]	7.5	12.5		17.5		22.5		27.5		32.5	
 [m]	2.6	35.00*	19.00	12.00	17.00	9.00	12.00	7.00			
	3.0	32.00*	19.00	12.00	17.00	9.00	12.00	7.00			
	3.5	28.80	19.00	12.00	17.00	9.00	12.00	7.00	9.00	7.00	
	4.0	26.00	19.00	12.00	17.00	9.00	12.00	7.00	9.00	7.00	
	4.5	23.00	19.00	12.00	17.00	9.00	12.00	7.00	9.00	7.00	7.00
	5.0	21.00	19.00	11.65	17.00	8.55	12.00	7.00	9.00	7.00	7.00
	5.5		19.00	10.95	15.85	8.00	12.00	6.90	9.00	7.00	7.00
	6.0		17.50	10.40	14.80	7.50	12.00	6.45	9.00	7.00	7.00
	6.5		16.00	9.85	13.80	7.05	12.00	6.05	9.00	7.00	7.00
	7.0		14.90	9.40	12.95	6.70	11.50	5.70	9.00	6.80	7.00
	8.0		12.15	8.60	11.50	6.00	10.30	5.10	8.60	6.10	7.00
	9.0		9.60	7.95	9.45	5.45	9.30	4.60	7.80	5.55	6.45
	10.0		7.70	7.50	7.60	5.00	8.35	4.15	7.10	5.05	5.90
	11.0				6.20	4.60	6.90	3.75	6.55	4.65	5.45
	12.0				5.15	4.25	5.80	3.40	6.00	4.25	5.00
	13.0				4.35	3.95	4.95	3.10	5.35	3.90	4.65
	14.0				3.65	3.65	4.25	2.85	4.65	3.60	4.30
	15.0				3.05	3.35	3.65	2.65	4.05	3.30	4.00
	16.0						3.15	2.45	3.50	3.05	3.75
	17.0						2.70	2.25	3.10	2.85	3.30
18.0						2.35	2.10	2.70	2.70	2.95	
19.0						2.00	2.00	2.35	2.50	2.60	
20.0						1.70	1.85	2.05	2.35	2.30	
22.0								1.55	2.10	1.80	
24.0								1.15	1.65	1.40	
26.0										1.10	
28.0										0.80	
30.0										0.55	
	ブーム2(%)	0	50	0	100	0	100	0	100	50	100
	ブーム3(%)	0	50	0	100	0	100	0	100	50	100
	ブーム4(%)	0	0	33	0	66	33	100	66	100	100
	ブーム5(%)	0	0	33	0	66	33	100	66	100	100
	ブーム6(%)	0	0	33	0	66	33	100	66	100	100
	MODE	A,B	A	B	A	B	A	B	A	B	A,B
 危険角度	[°]	—	—	—	—	—	—	—	—	—	—
 標準フック	[ton]	35	22								
 フック質量	[kg]	310	225								
 巻掛本数	[本]	10*8	6	4	6	4	4	4	4	4	4

(単位 : ton)









ブーム 	ジブ	アウトリガ  6.3m	作業範囲 
--	----	--	---

 [m]	7.5	12.5		17.5		22.5		27.5		32.5	
 [m]	2.6	34.00*	19.00	12.00	17.00	9.00	12.00	7.00			
	3.0	31.00*	19.00	12.00	17.00	9.00	12.00	7.00			
	3.5	27.50	19.00	12.00	17.00	9.00	12.00	7.00	9.00	7.00	
	4.0	24.50	19.00	12.00	17.00	9.00	12.00	7.00	9.00	7.00	
	4.5	22.50	19.00	12.00	17.00	9.00	12.00	7.00	9.00	7.00	
	5.0	20.50	19.00	11.65	17.00	8.55	12.00	7.00	9.00	7.00	
	5.5		18.50	10.95	15.85	8.00	12.00	6.90	9.00	7.00	
	6.0		17.00	10.40	14.80	7.50	12.00	6.45	9.00	7.00	
	6.5		15.50	9.85	13.80	7.05	12.00	6.05	9.00	7.00	
	7.0		13.75	9.40	12.95	6.70	11.50	5.70	9.00	6.80	
	8.0		10.35	8.60	10.25	6.00	10.30	5.10	8.60	6.10	
	9.0		8.15	7.95	8.00	5.45	8.75	4.60	7.80	5.55	
	10.0		6.55	7.50	6.45	5.00	7.15	4.15	7.10	5.05	
	11.0				5.25	4.60	5.90	3.75	6.35	4.65	
	12.0				4.35	4.25	4.95	3.40	5.35	4.25	
	13.0				3.60	3.95	4.20	3.10	4.60	3.90	
	14.0				3.00	3.65	3.60	2.85	3.95	3.60	
	15.0				2.50	3.35	3.05	2.65	3.45	3.30	
	16.0						2.65	2.45	3.00	3.05	
	17.0						2.25	2.25	2.60	2.85	
18.0						1.90	2.10	2.25	2.70		
19.0						1.60	2.00	2.00	2.45		
20.0						1.35	1.85	1.70	2.20		
22.0								1.25	1.75		
24.0								0.90	1.40		
26.0									0.80		
28.0									0.55		
	ブーム2 (%)	0	50	0	100	0	100	0	100	50	100
	ブーム3 (%)	0	50	0	100	0	100	0	100	50	100
	ブーム4 (%)	0	0	33	0	66	33	100	66	100	100
	ブーム5 (%)	0	0	33	0	66	33	100	66	100	100
	ブーム6 (%)	0	0	33	0	66	33	100	66	100	100
	MODE	A,B	A	B	A	B	A	B	A	B	A,B
 危険角度	[°]	-	-	-	-	-	-	-	-	-	6
 標準フック	[ton]	35	22								
 フック質量	[kg]	310	225								
 巻掛本数	[本]	10*/8	6	4	6	4	4	4	4	4	4



(単位 : ton)







ブーム 	ジブ	アウトリガ  5.2m	作業範囲 
--	----	--	---

 [m]	7.5	12.5		17.5		22.5		27.5		32.5	
 [m]	2.6	30.00	19.00	12.00	17.00	9.00	12.00	7.00			
	3.0	28.50	19.00	12.00	17.00	9.00	12.00	7.00			
	3.5	25.50	19.00	12.00	17.00	9.00	12.00	7.00	9.00	7.00	
	4.0	22.50	19.00	12.00	17.00	9.00	12.00	7.00	9.00	7.00	
	4.5	20.50	19.00	12.00	17.00	9.00	12.00	7.00	9.00	7.00	7.00
	5.0	18.50	18.50	11.65	17.00	8.55	12.00	7.00	9.00	7.00	7.00
	5.5		15.40	10.95	15.30	8.00	12.00	6.90	9.00	7.00	7.00
	6.0		12.80	10.40	12.70	7.50	12.00	6.45	9.00	7.00	7.00
	6.5		10.85	9.85	10.75	7.05	11.55	6.05	9.00	7.00	7.00
	7.0		9.30	9.40	9.20	6.70	10.00	5.70	9.00	6.80	7.00
	8.0		7.10	8.45	7.00	6.00	7.70	5.10	8.20	6.10	7.00
	9.0		5.55	6.85	5.45	5.45	6.15	4.60	6.60	5.55	6.45
	10.0		4.45	5.65	4.35	5.00	4.95	4.15	5.40	5.05	5.65
	11.0				3.50	4.60	4.10	3.75	4.50	4.65	4.75
	12.0				2.80	4.25	3.40	3.40	3.75	4.25	4.00
	13.0				2.30	3.80	2.85	3.10	3.20	3.65	3.40
	14.0				1.85	3.35	2.35	2.85	2.70	3.15	2.95
	15.0				1.45	2.95	2.00	2.65	2.30	2.75	2.55
	16.0						1.65	2.45	1.95	2.40	2.20
	17.0						1.35	2.25	1.70	2.10	1.90
	18.0						1.05	2.10	1.40	1.85	1.65
	19.0						0.85	1.95	1.20	1.65	1.40
	20.0						0.60	1.80	0.95	1.45	1.20
	22.0								0.60	1.10	0.80
24.0									0.80	0.50	
	ブーム2 (%)	0	50	0	100	0	100	0	100	50	100
	ブーム3 (%)	0	50	0	100	0	100	0	100	50	100
	ブーム4 (%)	0	0	33	0	66	33	100	66	100	100
	ブーム5 (%)	0	0	33	0	66	33	100	66	100	100
	ブーム6 (%)	0	0	33	0	66	33	100	66	100	100
	MODE	A,B	A	B	A	B	A	B	A	B	A,B
 危険角度	[°]	-	-	-	-	-	-	-	24	-	35
 標準フック	[ton]	35	22								
 フック質量	[kg]	310	225								
 巻掛本数	[本]	8	6	4	6	4	4	4	4	4	4

(単位 : ton)









ブーム 	ジブ	アウトリガ  4.2m	作業範囲 
--	----	--	---

 [m]		7.5	12.5	17.5	22.5	27.5	32.5					
 [m]	2.6	29.00	19.00	12.00	17.00	9.00	12.00	7.00				
	3.0	26.00	19.00	12.00	17.00	9.00	12.00	7.00				
	3.5	23.00	19.00	12.00	17.00	9.00	12.00	7.00	9.00	7.00		
	4.0	19.00	19.00	12.00	17.00	9.00	12.00	7.00	9.00	7.00		
	4.5	15.35	15.15	12.00	14.75	9.00	12.00	7.00	9.00	7.00	7.00	
	5.0	12.30	12.15	11.65	12.05	8.55	12.00	7.00	9.00	7.00	7.00	
	5.5		10.00	10.95	9.90	8.00	10.60	6.90	9.00	7.00	7.00	
	6.0		8.40	9.80	8.30	7.50	9.05	6.45	9.00	7.00	7.00	
	6.5		7.15	8.50	7.05	7.05	7.80	6.05	8.20	7.00	7.00	
	7.0		6.15	7.45	6.05	6.70	6.75	5.70	7.25	6.80	7.00	
	8.0		4.65	5.85	4.60	6.00	5.20	5.10	5.65	6.10	5.95	
	9.0		3.60	4.75	3.50	5.10	4.10	4.60	4.50	5.00	4.80	
	10.0		2.80	3.90	2.75	4.25	3.30	4.15	3.65	4.15	3.90	
	11.0				2.10	3.60	2.65	3.75	3.00	3.45	3.25	
	12.0				1.60	3.05	2.15	3.25	2.50	2.95	2.70	
	13.0				1.20	2.65	1.75	2.80	2.05	2.50	2.30	
	14.0				0.85	2.30	1.40	2.45	1.70	2.15	1.90	
	15.0				0.50	2.00	1.10	2.15	1.40	1.80	1.60	
	16.0						0.80	1.85	1.15	1.55	1.35	
	17.0						0.55	1.65	0.90	1.35	1.10	
	18.0							1.45	0.70	1.15	0.90	
	19.0							1.30		0.95	0.75	
20.0							1.15		0.80			
22.0									0.50			
	ブーム2(%)	0	50	0	100	0	100	0	100	50	100	
	ブーム3(%)	0	50	0	100	0	100	0	100	50	100	
	ブーム4(%)	0	0	33	0	66	33	100	66	100	100	
	ブーム5(%)	0	0	33	0	66	33	100	66	100	100	
	ブーム6(%)	0	0	33	0	66	33	100	66	100	100	
	MODE	A,B	A	B	A	B	A	B	A	B	A,B	
 危険角度	[°]	-	-	-	-	-	28	-	41	25	50	
 標準フック	[ton]	35	22									
 フック質量	[kg]	310	225									
 巻掛本数	[本]	8	6	4	6	4	4	4	4	4	4	





















(単位 : ton)

ブーム 	ジブ	アウトリガ  2.31m	作業範囲 
--	----	---	---











 [m]	7.5	12.5		17.5		22.5		27.5		32.5	
 [m]	2.6	15.70	15.10	12.00	12.85	9.00	12.00	7.00			
	3.0	11.90	11.75	12.00	10.45	9.00	10.25	7.00			
	3.5	8.90	8.80	10.25	8.30	9.00	8.35	7.00	7.00	7.00	
	4.0	6.95	6.80	8.15	6.70	8.65	6.90	7.00	5.95	6.60	
	4.5	5.55	5.40	6.70	5.35	7.10	5.80	7.00	5.10	5.75	4.95
	5.0	4.55	4.40	5.60	4.35	6.00	4.90	6.25	4.40	5.05	4.30
	5.5		3.60	4.75	3.55	5.15	4.15	5.35	3.80	4.45	3.80
	6.0		2.95	4.05	2.90	4.45	3.50	4.65	3.30	3.95	3.30
	6.5		2.45	3.50	2.35	3.85	2.95	4.05	2.90	3.50	2.90
	7.0		2.00	3.05	1.95	3.40	2.50	3.60	2.50	3.10	2.55
	8.0		1.35	2.35	1.25	2.65	1.80	2.85	1.90	2.45	2.00
	9.0			1.80		2.10	1.25	2.30	1.40	1.95	1.50
	10.0			1.40		1.70		1.85		1.55	
	11.0					1.35		1.50		1.20	
	12.0					1.10		1.25		0.90	
	13.0					0.85		1.00			
14.0					0.70		0.80				
15.0					0.55		0.65				
16.0							0.50				
	ブーム2 (%)	0	50	0	100	0	100	0	100	50	100
	ブーム3 (%)	0	50	0	100	0	100	0	100	50	100
	ブーム4 (%)	0	0	33	0	66	33	100	66	100	100
	ブーム5 (%)	0	0	33	0	66	33	100	66	100	100
	ブーム6 (%)	0	0	33	0	66	33	100	66	100	100
	MODE	A,B	A	B	A	B	A	B	A	B	A,B
 危険角度	[°]	-	36	-	56	-	62	32	67	60	71
 標準フック	[ton]	35	22								
 フック質量	[kg]	310	225								
 巻掛本数	[本]	8	6	4	6	4	4	4	4	4	4

(単位 : ton)























 ブーム	 ジブ 6.5m	 アウトリガ 6.8m	 作業範囲
--	--	--	---

 [m]	17.5								17.5									
	7		25		45		60		[°]	7		25		45		60		
	 [°]	 (m)	 (ton)	 (m)	 (ton)	 (m)	 (ton)	 (m)		 (ton)	 (m)	 (ton)	 (m)	 (ton)	 (m)	(ton)		
84.0	2.2	3.20	4.2	3.20	5.9	2.52	6.7	1.69	84.0	2.2	3.20	4.3	3.20	6.0	2.52	6.7	1.69	
80.0	3.9	3.20	5.8	3.20	7.4	2.41	8.1	1.65	80.0	4.0	3.20	5.9	3.20	7.5	2.40	8.1	1.65	
75.0	6.0	3.20	7.7	3.20	9.1	2.30	9.7	1.62	75.0	6.1	3.20	7.9	3.20	9.2	2.29	9.8	1.62	
70.0	8.0	3.20	9.6	3.20	10.8	2.22	11.2	1.60	70.0	8.0	3.20	9.7	2.82	10.9	2.22	11.3	1.60	
66.0	9.5	3.20	11.0	3.09	12.1	2.17	12.4	1.59	66.0	9.6	3.20	11.1	2.56	12.2	2.16	12.4	1.58	
63.0	10.6	3.20	12.1	2.99	13.0	2.16	13.2	1.58	63.0	10.6	3.01	12.1	2.41	13.0	2.08	13.2	1.58	
60.0	11.6	3.20	13.0	2.90	13.9	2.14			60.0	11.7	2.73	13.0	2.26	13.9	2.01			
55.0	13.3	3.20	14.6	2.78	15.2	2.13			55.0	13.3	2.36	14.5	2.01	15.2	1.85			
50.0	14.9	3.20	16.0	2.70	16.4	2.13			50.0	14.8	2.07	15.9	1.81	16.4	1.72			
46.0	16.0	2.91	17.0	2.65	17.3	2.10			46.0	15.9	1.89	16.9	1.69	17.2	1.62			
40.0	17.5	2.26	18.3	2.16					40.0	17.5	1.68	18.2	1.55					
35.0	18.6	1.87	19.2	1.80					35.0	18.6	1.55	19.1	1.45					
30.0	19.6	1.57	20.0	1.54					30.0	19.5	1.44	19.9	1.38					
26.0	20.2	1.36	20.5	1.32					26.0	20.2	1.38	20.4	1.28					
20.0	21.0	1.15							20.0	20.9	1.31							
15.0	21.5	1.03							15.0	21.4	1.19							
8.0	21.7	0.97							8.0	21.6	1.13							
	ブーム2 (%)	100								ブーム2 (%)	0							
	ブーム3 (%)	100								ブーム3 (%)	0							
	ブーム4 (%)	0								ブーム4 (%)	66							
	ブーム5 (%)	0								ブーム5 (%)	66							
	ブーム6 (%)	0								ブーム6 (%)	66							
	MODE	A								MODE	B							
 危険角度	[°]	7	25	45	62	[°]	7	25	45	62								
 標準フック	[ton]	4.5								[ton]	4.5							
 フック質量	kg	70								kg	70							
 巻掛本数	[本]	1								[本]	1							















ブーム 	ジブ  6.5m	アウトリガ  6.8m	作業範囲 
--	--	--	---

 [m]	32.5								
	7		25		45		60		
 [°]									
	(m)	(ton)	(m)	(ton)	(m)	(ton)	(m)	(ton)	
84.0	4.8	3.20	7.1	3.20	8.7	2.46	9.2	1.66	
82.0	6.4	3.20	8.6	3.20	10.1	2.40	10.5	1.65	
76.0	11.0	3.20	12.7	2.59	14.3	2.05	14.2	1.60	
70.0	14.9	2.54	16.3	2.06	17.4	1.80	17.6	1.57	
66.0	17.3	2.14	18.6	1.79	19.6	1.59	19.7	1.54	
63.0	19.0	1.90	20.3	1.62	21.1	1.45	21.0	1.45	
60.0	20.7	1.70	21.9	1.46	22.6	1.34			
56.0	22.7	1.27	23.9	1.17	24.5	1.15			
50.0	25.3	0.77	26.5	0.70	26.9	0.70			
46.0	26.9	0.53	28.2	0.45	28.3	0.45			
44.0	28.1	0.36	28.9	0.35					
	ブーム2 (%)	100							
	ブーム3 (%)	100							
	ブーム4 (%)	100							
	ブーム5 (%)	100							
	ブーム6 (%)	100							
	MODE	A,B							
	危険角度 [°]	43	43	45	45	45	45	62	62
標準フック [ton]	4.5								
フック質量 kg	70								
巻掛本数 [本]	1								

 ブーム	 ジブ 6.5m	 アウトリガ 6.3m	 作業範囲
--	--	--	---





















 [m]	17.5								17.5									
	7		25		45		60		 [°]	7		25		45		60		
	 (m)	 (ton)	 (m)	 (ton)	 (m)	 (ton)	 (m)	 (ton)		 (m)	 (ton)	 (m)	 (ton)	 (m)	 (ton)	 (m)	 (ton)	
84.0	2.2	3.20	4.2	3.20	5.9	2.52	6.7	1.69	84.0	2.2	3.20	4.3	3.20	6.0	2.52	6.7	1.69	
80.0	3.9	3.20	5.8	3.20	7.4	2.41	8.1	1.65	80.0	4.0	3.20	5.9	3.20	7.5	2.40	8.1	1.65	
75.0	6.0	3.20	7.7	3.20	9.1	2.30	9.7	1.62	75.0	6.1	3.20	7.9	3.20	9.2	2.29	9.8	1.62	
70.0	8.0	3.20	9.6	3.20	10.8	2.22	11.2	1.60	70.0	8.0	3.20	9.7	2.82	10.9	2.22	11.3	1.60	
66.0	9.5	3.20	11.0	3.09	12.1	2.17	12.4	1.59	66.0	9.6	3.20	11.1	2.56	12.2	2.16	12.4	1.58	
63.0	10.6	3.20	12.0	2.99	13.0	2.16	13.2	1.58	63.0	10.6	3.01	12.1	2.41	13.0	2.08	13.2	1.58	
60.0	11.6	3.20	13.1	2.90	13.9	2.14			60.0	11.7	2.73	13.0	2.26	13.9	2.01			
55.0	13.3	3.20	14.6	2.78	15.2	2.13			55.0	13.3	2.36	14.5	2.01	15.2	1.85			
50.0	14.9	2.98	16.0	2.70	16.4	2.13			50.0	14.8	2.07	15.9	1.81	16.4	1.72			
46.0	16.0	2.44	16.9	2.27	17.3	2.10			46.0	15.9	1.89	16.9	1.69	17.2	1.62			
40.0	17.5	1.86	18.2	1.77					40.0	17.5	1.68	18.2	1.55					
35.0	18.6	1.49	19.2	1.45					35.0	18.6	1.55	19.1	1.45					
30.0	19.6	1.21	20.0	1.20					30.0	19.5	1.44	19.9	1.38					
26.0	20.2	1.02	20.5	0.98					26.0	20.2	1.38	20.4	1.28					
20.0	21.0	0.83							20.0	20.9	1.31							
15.0	21.5	0.72							15.0	21.4	1.19							
8.0	21.7	0.67							8.0	21.6	1.13							
 危険角度	ブーム2 (%)	100								ブーム2 (%)	0							
	ブーム3 (%)	100								ブーム3 (%)	0							
	ブーム4 (%)	0								ブーム4 (%)	66							
	ブーム5 (%)	0								ブーム5 (%)	66							
	ブーム6 (%)	0								ブーム6 (%)	66							
	MODE	A								MODE	B							
 危険角度	[°]	7	25	45	62	[°]	7	25	45	62								
 標準フック	[ton]	4.5								[ton]	4.5							
 フック質量	kg	70								kg	70							
 巻掛本数	[本]	1								[本]	1							

 ブーム	 ジブ 6.5m	 アウトリガ 6.3m	 作業範囲
---	---	---	--

















 [m]	32.5								
	7		25		45		60		
 [°]									
	 (m)	 (ton)	 (m)	 (ton)	 (m)	 (ton)	 (m)	 (ton)	
84.0	4.8	3.20	7.1	3.20	8.7	2.46	9.2	1.66	
82.0	6.4	3.20	8.6	3.20	10.1	2.40	10.5	1.65	
76.0	11.0	3.20	12.7	2.59	14.3	2.05	14.2	1.60	
70.0	14.9	2.54	16.3	2.06	17.4	1.80	17.6	1.57	
66.0	17.3	2.14	18.6	1.79	19.6	1.59	19.7	1.54	
63.0	19.0	1.86	20.3	1.62	21.1	1.45	21.0	1.45	
60.0	20.5	1.44	21.8	1.32	22.6	1.26			
56.0	22.5	1.00	23.7	0.92	24.4	0.90			
50.0	25.4	0.50	26.4	0.47	26.8	0.47			
48.0	26.3	0.38	27.3	0.35	27.5	0.35			
	ブーム2 (%)	100							
	ブーム3 (%)	100							
	ブーム4 (%)	100							
	ブーム5 (%)	100							
	ブーム6 (%)	100							
	MODE	A,B							
 危険角度 [°]	47		47		47		62		
 標準フック [ton]	4.5								
 フック質量 kg	70								
 巻掛本数 [本]	1								



























 ブーム	 ジブ 6.5m	 アウトリガ 5.2m	 作業範囲
--	--	--	---

 [m]	17.5								17.5									
	7		25		45		60		[°]	7		25		45		60		
	 (m)	 (ton)	 (m)	 (ton)	 (m)	 (ton)	 (m)	 (ton)		 (m)	 (ton)	 (m)	 (ton)	 (m)	 (ton)			
84.0	2.2	3.20	4.2	3.20	5.9	2.52	6.7	1.69	84.0	2.2	3.20	4.3	3.20	6.0	2.52	6.7	1.69	
80.0	3.9	3.20	5.8	3.20	7.4	2.41	8.1	1.65	80.0	4.0	3.20	5.9	3.20	7.5	2.40	8.1	1.65	
75.0	6.0	3.20	7.7	3.20	9.1	2.30	9.7	1.62	75.0	6.1	3.20	7.9	3.20	9.2	2.29	9.8	1.62	
70.0	8.0	3.20	9.6	3.20	10.8	2.22	11.2	1.60	70.0	8.0	3.20	9.7	2.82	10.9	2.22	11.3	1.60	
66.0	9.5	3.20	11.0	3.09	12.1	2.17	12.4	1.59	66.0	9.6	3.20	11.1	2.56	12.2	2.16	12.4	1.58	
63.0	10.6	3.20	12.1	2.99	13.0	2.16	13.2	1.58	63.0	10.6	3.01	12.1	2.41	13.0	2.08	13.2	1.58	
60.0	11.6	3.20	13.0	2.90	13.9	2.14			60.0	11.7	2.73	13.0	2.26	13.9	2.01			
55.0	13.3	2.60	14.5	2.28	15.2	2.13			55.0	13.3	2.36	14.5	2.01	15.2	1.85			
50.0	14.8	1.87	15.9	1.70	16.4	1.65			50.0	14.8	2.07	15.9	1.81	16.4	1.72			
46.0	15.9	1.45	16.9	1.34	17.2	1.33			46.0	15.9	1.89	16.9	1.69	17.2	1.62			
40.0	17.4	0.98	18.2	0.93					40.0	17.5	1.68	18.2	1.55					
35.0	18.5	0.68	19.2	0.66					35.0	18.6	1.55	19.1	1.45					
30.0	19.5	0.45	20.0	0.45					30.0	19.5	1.44	19.9	1.38					
28.0	19.9	0.37	20.2	0.37					28.0	19.9	1.41	20.4	1.28					
27.0	20.0	0.33							27.0	20.0	1.39							
									26.0	20.2	1.38							
									20.0	20.9	1.26							
									15.0	21.4	1.18							
									8.0	21.6	1.13							
	ブーム2 (%)	100								ブーム2 (%)	0							
	ブーム3 (%)	100								ブーム3 (%)	0							
	ブーム4 (%)	0								ブーム4 (%)	66							
	ブーム5 (%)	0								ブーム5 (%)	66							
	ブーム6 (%)	0								ブーム6 (%)	66							
	MODE	A								MODE	B							
	[°]	26	27	45	62	[°]	7	25	45	62								
	[ton]	4.5								[ton]	4.5							
	kg	70								kg	70							
	[本]	1								[本]	1							

















 ブーム	 ジブ 6.5m	 アウトリガ 5.2m	 作業範囲
---	---	---	--

 [m]	32.5								
 [°]	7		25		45		60		
 [°]									
	(m)	(ton)	(m)	(ton)	(m)	(ton)	(m)	(ton)	
84.0	4.8	3.20	7.1	3.20	8.7	2.46	9.2	1.66	
82.0	6.4	3.20	8.6	3.20	10.1	2.40	10.5	1.65	
76.0	11.0	3.20	12.7	2.59	14.3	2.05	14.2	1.60	
70.0	14.9	2.34	16.3	2.06	17.4	1.80	17.6	1.57	
66.0	17.0	1.58	18.4	1.40	19.5	1.30	19.6	1.30	
63.0	18.6	1.13	20.0	1.01	20.9	0.95	20.9	0.95	
60.0	20.2	0.77	21.5	0.69	22.3	0.66			
59.0	20.7	0.67	22.0	0.60	22.8	0.58			
	ブーム2 (%)	100							
	ブーム3 (%)	100							
	ブーム4 (%)	100							
	ブーム5 (%)	100							
	ブーム6 (%)	100							
	MODE	A,B							
 危険角度 [°]	58		58		58		62		
 標準フック [ton]	4.5								
 フック質量 kg	70								
 巻掛本数 [本]	1								



































 ブーム	 ジブ 6.5m	 アウトリガ 4.2m	 作業範囲
--	--	--	---

 [m]	17.5								17.5									
	7		25		45		60		 [°]	7		25		45		60		
	 [°]	 (m)	 (ton)	 [°]	 (m)	 (ton)	 [°]	 (m)		 (ton)	 [°]	 (m)	 (ton)	 [°]	 (m)	 (ton)	 [°]	 (m)
84.0	2.2	3.20	4.2	3.20	5.9	2.52	6.7	1.69	84.0	2.2	3.20	4.3	3.20	6.0	2.52	6.7	1.69	
80.0	3.9	3.20	5.8	3.20	7.4	2.41	8.1	1.65	80.0	4.0	3.20	5.9	3.20	7.5	2.40	8.1	1.65	
75.0	6.0	3.20	7.7	3.20	9.1	2.30	9.7	1.62	75.0	6.1	3.20	7.9	3.20	9.2	2.29	9.8	1.62	
70.0	8.0	3.20	9.6	3.20	10.8	2.22	11.2	1.60	70.0	8.0	3.20	9.7	2.82	10.9	2.22	11.3	1.60	
66.0	9.5	3.20	11.1	3.00	12.1	2.17	12.4	1.59	66.0	9.6	3.20	11.1	2.56	12.2	2.16	12.4	1.58	
63.0	10.5	2.94	12.1	2.42	13.0	2.16	13.2	1.58	63.0	10.6	3.01	12.1	2.41	13.0	2.08	13.2	1.58	
60.0	11.6	2.34	13.0	1.99	13.8	1.85			60.0	11.7	2.73	13.0	2.26	13.9	2.01			
55.0	13.2	1.57	14.5	1.35	15.2	1.28			55.0	13.3	2.36	14.5	2.01	15.2	1.85			
50.0	14.7	0.99	15.8	0.88	16.4	0.86			50.0	14.8	2.01	15.9	1.81	16.4	1.72			
46.0	15.8	0.65	16.8	0.60	17.2	0.59			46.0	15.9	1.70	16.8	1.58	17.2	1.55			
42.0	16.8	0.39	17.7	0.36					42.0	16.9	1.46	17.7	1.37					
41.0	17.1	0.33							41.0	17.2	1.40	18.0	1.33					
									40.0	17.4	1.34	18.2	1.28					
									35.0	18.5	1.10	19.1	1.07					
									30.0	19.5	0.92	19.9	0.91					
									26.0	20.1	0.80	20.4	0.78					
									20.0	20.9	0.67							
									15.0	21.4	0.60							
									8.0	21.6	0.56							
	ブーム2 (%)	100								ブーム2 (%)	0							
	ブーム3 (%)	100								ブーム3 (%)	0							
	ブーム4 (%)	0								ブーム4 (%)	66							
	ブーム5 (%)	0								ブーム5 (%)	66							
	ブーム6 (%)	0								ブーム6 (%)	66							
	MODE	A								MODE	B							
 危険角度	[°]	40	41	45	62	[°]	7	25	45	62								
 標準フック	[ton]	4.5								[ton]	4.5							
 フック質量	kg	70								kg	70							
 巻掛本数	[本]	1								[本]	1							



















ブーム 	ジブ  6.5m	アウトリガ  4.2m	作業範囲 
--	--	--	---

 [m]	32.5							
	7		25		45		60	
 [°]								
 [°]	 (m)	 (ton)	 (m)	 (ton)	 (m)	 (ton)	 (m)	 (ton)
	84.0	4.8	3.20	7.1	3.20	8.7	2.46	9.2
82.0	6.4	3.20	8.6	3.20	10.1	2.40	10.5	1.65
76.0	11.0	3.00	12.7	2.57	14.3	2.05	14.2	1.60
70.0	14.4	1.56	16.0	1.34	17.1	1.22	17.5	1.20
67.0	16.1	1.05	17.6	0.90	18.7	0.82	18.9	0.82
	ブーム2 (%)	100						
	ブーム3 (%)	100						
	ブーム4 (%)	100						
	ブーム5 (%)	100						
	ブーム6 (%)	100						
	MODE	A,B						
 [°]	66		66		66		66	
 [ton]	4.5							
 kg	70							
 [本]	1							

 ブーム	 ジブ 10.25m	 アウトリガ 6.8m	 作業範囲
--	--	--	---



























 [m]	17.5								17.5									
	5		25		45		60		[°]	5		25		45		60		
	 (m)  (ton)	 (m)  (ton)	 (m)  (ton)	 (m)  (ton)	 (m)  (ton)	 (m)  (ton)	 (m)  (ton)	 (m)  (ton)		[°]	 (m)  (ton)	 (m)  (ton)	 (m)  (ton)	 (m)  (ton)	 (m)  (ton)	 (m)  (ton)	 (m)  (ton)	 (m)  (ton)
84.0	2.7	2.00	6.2	1.90	8.9	1.34	10.2	0.95	84.0		2.9	2.00	6.4	1.90	9.0	1.33	10.3	0.94
80.0	4.7	2.00	8.1	1.89	10.5	1.28	11.6	0.92	80.0	4.9	2.00	8.3	1.87	10.7	1.26	11.8	0.91	
75.0	7.2	2.00	10.3	1.74	12.5	1.21	13.4	0.90	75.0	7.3	2.00	10.5	1.73	12.6	1.20	13.5	0.89	
70.0	9.5	2.00	12.4	1.61	14.3	1.17	15.0	0.89	70.0	9.7	2.00	12.6	1.61	14.4	1.15	15.0	0.88	
66.0	11.2	2.00	13.9	1.53	15.6	1.13	16.1	0.88	66.0	11.4	2.00	14.1	1.52	15.7	1.12	16.2	0.88	
63.0	12.5	2.00	15.1	1.47	16.6	1.12	16.8	0.88	63.0	12.7	1.95	15.3	1.47	16.7	1.11	16.8	0.88	
60.0	13.7	1.90	16.1	1.43	17.5	1.11			60.0	13.9	1.85	16.3	1.42	17.5	1.10			
55.0	15.6	1.71	17.8	1.40	18.9	1.09			55.0	15.8	1.67	18.0	1.37	18.9	1.09			
50.0	17.4	1.58	19.3	1.35	20.1	1.08			50.0	17.6	1.53	19.5	1.27	20.1	1.08			
46.0	18.7	1.49	20.5	1.31	21.0	1.08			46.0	18.9	1.39	20.6	1.19	20.9	1.08			
40.0	20.6	1.39	21.9	1.28					40.0	20.7	1.24	22.0	1.10					
35.0	21.9	1.32	22.9	1.26					35.0	21.9	1.14	22.9	1.04					
30.0	23.0	1.23	23.7	1.21					30.0	23.0	1.06	23.7	1.00					
26.0	23.7	1.07	24.3	1.04					26.0	23.8	1.01	24.2	0.97					
20.0	24.6	0.90							20.0	24.7	0.96							
15.0	25.1	0.81							15.0	25.2	0.93							
6.0	25.5	0.75							6.0	25.4	0.90							
	ブーム2 (%)	100								ブーム2 (%)	0							
	ブーム3 (%)	100								ブーム3 (%)	0							
	ブーム4 (%)	0								ブーム4 (%)	66							
	ブーム5 (%)	0								ブーム5 (%)	66							
	ブーム6 (%)	0								ブーム6 (%)	66							
	MODE	A								MODE	B							
危険角度 [°]	5	25	45	62					[°]	5	25	45	62					
標準フック [ton]	4.5								[ton]	4.5								
フック質量 kg	70								kg	70								
巻掛本数 [本]	1								[本]	1								

 ブーム	 ジブ 10.25m	 アウトリガ 6.8m	 作業範囲
---	---	---	--













 [m]	32.5								
	5		25		45		60		
 [°]	 (m)	 (ton)	 (m)	 (ton)	 (m)	 (ton)	 (m)	 (ton)	
	84.0	5.6	2.00	9.4	1.90	11.6	1.25	12.8	0.91
80.0	9.0	2.00	12.5	1.78	14.5	1.20	15.4	0.90	
75.0	13.1	2.00	16.0	1.60	17.8	1.14	18.4	0.88	
71.0	16.0	2.00	18.7	1.44	20.3	1.11	20.6	0.87	
66.0	19.5	1.66	21.8	1.25	23.2	1.07	23.3	0.86	
63.0	21.4	1.47	23.6	1.15	24.8	1.01	24.4	0.86	
60.0	23.2	1.32	25.3	1.04	26.3	0.94			
55.0	25.9	0.94	27.9	0.86	28.6	0.83			
50.0	28.4	0.58	30.2	0.54	30.7	0.54			
46.0	30.3	0.36	31.8	0.34	32.1	0.34			
45.0	30.7	0.31	32.2	0.30					
 ブーム2 (%)	100								
	 ブーム3 (%)	100							
		 ブーム4 (%)	100						
	 ブーム5 (%)		100						
		 ブーム6 (%)	100						
	MODE		A,B						
	 危険角度 [°]	44		44		45		62	
 標準フック [ton]	4.5								
 フック質量 kg	70								
 巻掛本数 [本]	1								























 ブーム	 ジブ 10.25m	 アウトリガ 6.3m	 作業範囲
--	--	--	---

 [m]	17.5								17.5									
	5		25		45		60		[°]	5		25		45		60		
	 (m)  (ton)	 (m)  (ton)	 (m)  (ton)	 (m)  (ton)	 (m)  (ton)	 (m)  (ton)	 (m)  (ton)	 (m)  (ton)		[°]	 (m)  (ton)	 (m)  (ton)	 (m)  (ton)	(m)  (ton)	(m)  (ton)	(m)  (ton)	(m)  (ton)	
84.0	2.7	2.00	6.2	1.90	8.9	1.34	10.2	0.95	84.0		2.9	2.00	6.4	1.90	9.0	1.33	10.3	0.94
80.0	4.7	2.00	8.1	1.89	10.5	1.28	11.6	0.92	80.0	4.9	2.00	8.3	1.87	10.7	1.26	11.8	0.91	
75.0	7.2	2.00	10.3	1.74	12.5	1.21	13.4	0.90	75.0	7.3	2.00	10.5	1.73	12.6	1.20	13.5	0.89	
70.0	9.5	2.00	12.4	1.61	14.3	1.17	15.0	0.89	70.0	9.7	2.00	12.6	1.61	14.4	1.15	15.0	0.88	
66.0	11.2	2.00	13.9	1.53	15.6	1.13	16.1	0.88	66.0	11.4	2.00	14.1	1.52	15.7	1.12	16.2	0.88	
63.0	12.5	2.00	15.1	1.47	16.6	1.12	16.8	0.88	63.0	12.7	1.95	15.3	1.47	16.7	1.11	16.8	0.88	
60.0	13.7	1.90	16.1	1.43	17.5	1.11			60.0	13.9	1.85	16.3	1.42	17.5	1.10			
55.0	15.6	1.71	17.8	1.40	18.9	1.09			55.0	15.8	1.67	18.0	1.37	18.9	1.09			
50.0	17.4	1.58	19.3	1.35	20.1	1.08			50.0	17.6	1.53	19.5	1.27	20.1	1.08			
46.0	18.7	1.49	20.5	1.31	21.0	1.08			46.0	18.9	1.39	20.6	1.19	20.9	1.08			
40.0	20.6	1.39	21.9	1.28					40.0	20.7	1.24	22.0	1.10					
35.0	21.8	1.17	22.9	1.12					35.0	21.9	1.14	22.9	1.04					
30.0	22.9	0.94	23.7	0.93					30.0	23.0	1.06	23.7	1.00					
26.0	23.7	0.79	24.3	0.77					26.0	23.8	1.01	24.2	0.97					
20.0	24.6	0.64							20.0	24.7	0.96							
15.0	25.1	0.55							15.0	25.2	0.93							
6.0	25.5	0.49							6.0	25.4	0.90							
	ブーム2 (%)	100								ブーム2 (%)	0							
	ブーム3 (%)	100								ブーム3 (%)	0							
	ブーム4 (%)	0								ブーム4 (%)	66							
	ブーム5 (%)	0								ブーム5 (%)	66							
	ブーム6 (%)	0								ブーム6 (%)	66							
	MODE	A								MODE	B							
 危険角度	[°]	5	25	45	62	[°]	5	25	45	62								
 標準フック	[ton]	4.5								[ton]	4.5							
 フック質量	kg	70								kg	70							
 巻掛本数	[本]	1								[本]	1							

















ブーム 	ジブ  10.25m	アウトリガ  6.3m	作業範囲 
--	--	--	---

 [m]	32.5								
	5		25		45		60		
 [°]									
 [°]									
	(m)	(ton)	(m)	(ton)	(m)	(ton)	(m)	(ton)	
84.0	5.6	2.00	9.4	1.90	11.6	1.25	12.8	0.91	
80.0	9.0	2.00	12.5	1.78	14.5	1.20	15.4	0.90	
75.0	13.1	2.00	16.0	1.60	17.8	1.14	18.4	0.88	
71.0	16.0	2.00	18.7	1.44	20.3	1.11	20.6	0.87	
66.0	19.5	1.66	21.8	1.25	23.2	1.07	23.3	0.86	
63.0	21.4	1.47	23.6	1.15	24.8	1.01	24.4	0.86	
60.0	23.2	1.14	25.3	1.02	26.3	0.94			
55.0	25.8	0.71	27.7	0.65	28.5	0.65			
50.0	28.3	0.38	30.0	0.36	30.5	0.36			
	ブーム2 (%)	100							
	ブーム3 (%)	100							
	ブーム4 (%)	100							
	ブーム5 (%)	100							
	ブーム6 (%)	100							
	MODE	A,B							
	危険角度 [°]	49		49		49		62	
標準フック [ton]	4.5								
フック質量 [kg]	70								
巻掛本数 [本]	1								

























 ブーム	 ジブ 10.25m	 アウトリガ 5.2m	 作業範囲
--	--	--	---

 [m]	17.5								17.5									
	5		25		45		60		[°]	5		25		45		60		
	 (m)	 (ton)	 (m)	 (ton)	 (m)	 (ton)	 (m)	 (ton)		 (m)	 (ton)	 (m)	 (ton)	 (m)	 (ton)			
84.0	2.7	2.00	6.2	1.90	8.9	1.34	10.2	0.95	84.0	2.9	2.00	6.4	1.90	9.0	1.33	10.3	0.94	
80.0	4.7	2.00	8.1	1.89	10.5	1.28	11.6	0.92	80.0	4.9	2.00	8.3	1.87	10.7	1.26	11.8	0.91	
75.0	7.2	2.00	10.3	1.74	12.5	1.21	13.4	0.90	75.0	7.3	2.00	10.5	1.73	12.6	1.20	13.5	0.89	
70.0	9.5	2.00	12.4	1.61	14.3	1.17	15.0	0.89	70.0	9.7	2.00	12.6	1.61	14.4	1.15	15.0	0.88	
66.0	11.2	2.00	13.9	1.53	15.6	1.13	16.1	0.88	66.0	11.4	2.00	14.1	1.52	15.7	1.12	16.2	0.88	
63.0	12.5	2.00	15.1	1.47	16.6	1.12	16.8	0.88	63.0	12.7	1.95	15.3	1.47	16.7	1.11	16.8	0.88	
60.0	13.7	1.90	16.1	1.43	17.5	1.11			60.0	13.9	1.85	16.3	1.42	17.5	1.10			
55.0	15.6	1.71	17.8	1.40	18.9	1.09			55.0	15.8	1.67	18.0	1.37	18.9	1.09			
50.0	17.4	1.47	19.3	1.28	20.1	1.08			50.0	17.6	1.53	19.5	1.27	20.1	1.08			
46.0	18.7	1.13	20.4	1.01	21.0	1.01			46.0	18.9	1.39	20.6	1.19	20.9	1.08			
40.0	20.4	0.75	21.9	0.69					40.0	20.7	1.24	22.0	1.10					
35.0	21.7	0.51	22.9	0.49					35.0	21.9	1.14	22.9	1.04					
31.0	22.7	0.35	23.6	0.35					31.0	22.8	1.08	23.6	1.01					
30.0	22.9	0.32							30.0	23.0	1.06	23.7	1.00					
									26.0	23.8	1.01	24.2	0.97					
									20.0	24.7	0.96							
									15.0	25.1	0.93							
									6.0	25.4	0.88							
	ブーム2 (%)	100								ブーム2 (%)	0							
	ブーム3 (%)	100								ブーム3 (%)	0							
	ブーム4 (%)	0								ブーム4 (%)	66							
	ブーム5 (%)	0								ブーム5 (%)	66							
	ブーム6 (%)	0								ブーム6 (%)	66							
	MODE	A								MODE	B							
 危険角度	[°]	29	30	45	62	[°]	5	25	45	62								
 標準フック	[ton]	4.5								[ton]	4.5							
 フック質量	kg	70								kg	70							
 巻掛本数	[本]	1								[本]	1							













ブーム 	ジブ  10.25m	アウトリガ  5.2m	作業範囲 
--	--	--	---

 [m]	32.5								
 [°]	5		25		45		60		
 [°]									
	(m)	(ton)	(m)	(ton)	(m)	(ton)	(m)	(ton)	
84.0	5.6	2.00	9.4	1.90	11.6	1.25	12.8	0.91	
80.0	9.0	2.00	12.5	1.78	14.5	1.20	15.4	0.90	
75.0	13.1	2.00	16.0	1.60	17.8	1.14	18.4	0.88	
71.0	16.0	2.00	18.7	1.44	20.3	1.11	20.6	0.87	
66.0	19.1	1.29	21.8	1.04	23.2	0.99	23.3	0.86	
63.0	20.8	0.91	23.3	0.77	24.6	0.73	24.4	0.72	
61.0	22.0	0.70	24.3	0.60	25.6	0.57			
	ブーム2 (%)	100							
	ブーム3 (%)	100							
	ブーム4 (%)	100							
	ブーム5 (%)	100							
	ブーム6 (%)	100							
	MODE	A,B							
 危険角度 [°]	60		60		60		62		
 標準フック [ton]	4.5								
 フック質量 kg	70								
 巻掛本数 [本]	1								

 ブーム	 ジブ 10.25m	 アウトリガ 4.2m	 作業範囲
--	--	--	---



















 [m]	17.5								17.5									
	5		25		45		60		 [°]	5		25		45		60		
	 [°]	 (m)	 (ton)	 [°]	 (m)	 (ton)	 [°]	 (m)		 (ton)	 [°]	 (m)	 (ton)	 [°]	 (m)	 (ton)	 [°]	 (m)
84.0	2.7	2.00	6.2	1.90	8.9	1.34	10.2	0.95	84.0	2.9	2.00	6.4	1.90	9.0	1.33	10.3	0.94	
80.0	4.7	2.00	8.1	1.89	10.5	1.28	11.6	0.92	80.0	4.9	2.00	8.3	1.87	10.7	1.26	11.8	0.91	
75.0	7.2	2.00	10.3	1.74	12.5	1.21	13.4	0.90	75.0	7.3	2.00	10.5	1.73	12.6	1.20	13.5	0.89	
70.0	9.5	2.00	12.4	1.61	14.3	1.17	15.0	0.89	70.0	9.7	2.00	12.6	1.61	14.4	1.15	15.0	0.88	
66.0	11.2	2.00	13.9	1.53	15.6	1.13	16.1	0.88	66.0	11.4	2.00	14.1	1.52	15.7	1.12	16.2	0.88	
63.0	12.5	2.00	15.1	1.47	16.6	1.12	16.8	0.88	63.0	12.7	1.95	15.3	1.47	16.7	1.11	16.8	0.88	
60.0	13.7	1.86	16.1	1.43	17.5	1.11			60.0	13.9	1.85	16.3	1.42	17.5	1.10			
55.0	15.6	1.22	17.8	1.00	18.8	0.95			55.0	15.8	1.67	18.0	1.37	18.9	1.09			
50.0	17.3	0.76	19.3	0.64	20.1	0.62			50.0	17.6	1.53	19.5	1.27	20.1	1.08			
46.0	18.6	0.48	20.3	0.42	20.9	0.42			46.0	18.9	1.34	20.6	1.19	20.9	1.08			
45.0	18.9	0.42	20.6	0.37					45.0	19.2	1.29	20.8	1.16					
43.0	19.5	0.31							43.0	19.8	1.18	21.2	1.08					
									40.0	20.6	1.04	21.9	0.97					
									35.0	21.9	0.85	22.9	0.82					
									30.0	23.0	0.70	23.7	0.69					
									26.0	23.7	0.60	24.2	0.60					
									20.0	24.6	0.50							
									15.0	25.2	0.44							
									6.0	25.4	0.41							
	ブーム2 (%)	100								ブーム2 (%)	0							
	ブーム3 (%)	100								ブーム3 (%)	0							
	ブーム4 (%)	0								ブーム4 (%)	66							
	ブーム5 (%)	0								ブーム5 (%)	66							
	ブーム6 (%)	0								ブーム6 (%)	66							
	MODE	A								MODE	B							
 危険角度	[°]	42	44	45	62	[°]	5	25	45	62								
 標準フック	[ton]	4.5								[ton]	4.5							
 フック質量	kg	70								kg	70							
 巻掛本数	[本]	1								[本]	1							

ブーム 	ジブ  10.25m	アウトリガ  4.2m	作業範囲 
--	--	--	---











 [m]	32.5								
	5		25		45		60		
 [°]									
 [°]	 (m)	 (ton)	 (m)	 (ton)	 (m)	 (ton)	 (m)	 (ton)	
	84.0	5.6	2.00	9.4	1.90	11.6	1.25	12.8	0.91
80.0	9.0	2.00	12.5	1.78	14.5	1.20	15.4	0.90	
75.0	13.1	2.00	16.0	1.60	17.8	1.14	18.4	0.88	
71.0	15.7	1.40	18.5	1.13	20.3	0.99	20.6	0.87	
69.0	16.9	1.09	19.6	0.87	21.2	0.79	21.7	0.79	
68.0	17.5	0.95							
	ブーム2 (%)	100							
	ブーム3 (%)	100							
	ブーム4 (%)	100							
	ブーム5 (%)	100							
	ブーム6 (%)	100							
	MODE	A,B							
	危険角度 [°]	67		68		68		68	
標準フック [ton]	4.5								
フック質量 kg	70								
巻掛本数 [本]	1								























 ブーム	 ジブ 14.0m	 アウトリガ 6.8m	 作業範囲
--	---	--	---

 [m]	17.5								17.5									
	5		25		45		60		[°]	5		25		45		60		
	 [°]	 (m)	 (ton)	 (m)	 (ton)	 (m)	 (ton)	 (m)		 (ton)	 (m)	 (ton)	 (m)	 (ton)	(m)	(ton)	(m)	(ton)
84.0	3.5	1.35	8.3	0.93	11.8	0.55	13.7	0.43	84.0	3.7	1.35	8.5	0.91	12.0	0.53	13.8	0.43	
80.0	5.9	1.35	10.4	0.86	13.6	0.52	15.2	0.42	80.0	6.1	1.35	10.5	0.83	13.8	0.51	15.3	0.42	
75.0	8.6	1.35	12.8	0.77	15.8	0.49	17.0	0.41	75.0	8.9	1.33	13.0	0.75	15.9	0.49	17.1	0.41	
70.0	11.2	1.20	15.1	0.70	17.7	0.47	18.7	0.41	70.0	11.5	1.18	15.3	0.69	17.8	0.47	18.7	0.41	
66.0	13.2	1.01	16.9	0.66	19.1	0.46	19.8	0.41	66.0	13.4	1.00	17.0	0.65	19.2	0.46	19.8	0.41	
63.0	14.7	0.92	18.1	0.63	20.1	0.45	20.6	0.41	63.0	14.8	0.92	18.2	0.62	20.2	0.45	20.6	0.41	
60.0	16.0	0.87	19.3	0.61	21.1	0.45			60.0	16.1	0.87	19.4	0.60	21.2	0.45			
55.0	18.2	0.81	21.1	0.58	22.5	0.45			55.0	18.3	0.81	21.2	0.57	22.6	0.44			
50.0	20.3	0.77	22.8	0.56	23.8	0.44			50.0	20.3	0.77	22.9	0.56	23.7	0.44			
46.0	21.7	0.74	24.0	0.55	24.7	0.42			46.0	21.7	0.74	24.0	0.55	24.6	0.42			
40.0	23.7	0.70	25.6	0.53					40.0	23.7	0.70	25.5	0.53					
35.0	25.2	0.66	26.6	0.53					35.0	25.2	0.66	26.6	0.53					
30.0	26.5	0.63	27.4	0.53					30.0	26.4	0.63	27.4	0.53					
26.0	27.3	0.61	27.9	0.53					26.0	27.3	0.61	27.9	0.53					
20.0	28.3	0.58							20.0	28.3	0.58							
15.0	28.9	0.57							15.0	28.8	0.57							
6.0	29.2	0.55							6.0	29.2	0.55							
 ブーム	ブーム2 (%)	100								ブーム2 (%)	0							
	ブーム3 (%)	100								ブーム3 (%)	0							
	ブーム4 (%)	0								ブーム4 (%)	66							
	ブーム5 (%)	0								ブーム5 (%)	66							
	ブーム6 (%)	0								ブーム6 (%)	66							
	MODE	A								MODE	B							
 危険角度	[°]	5	25	45	62	[°]	5	25	45	62								
 標準フック	[ton]	4.5								[ton]	4.5							
 フック質量	kg	70								kg	70							
 巻掛本数	[本]	1								[本]	1							











 ブーム	 ジブ 14.0m	 アウトリガ 6.8m	 作業範囲
---	--	---	--

 [m]	32.5							
	5		25		45		60	
 [°]								
	 (m)	 (ton)	 (m)	 (ton)	 (m)	 (ton)	 (m)	 (ton)
84.0	6.4	1.35	11.1	0.85	14.4	0.50	16.1	0.40
80.0	10.1	1.35	14.4	0.76	17.4	0.48	18.8	0.40
76.0	13.5	1.35	17.5	0.69	20.3	0.46	21.3	0.39
72.0	16.9	1.18	20.5	0.65	22.8	0.45	23.6	0.39
70.0	18.5	1.07	21.9	0.63	24.1	0.44	24.7	0.39
66.0	21.4	0.92	24.6	0.59	26.5	0.43	26.9	0.39
64.0	22.8	0.88	25.9	0.58	27.7	0.43	27.9	0.39
60.0	25.6	0.82	28.4	0.55	29.8	0.43		
55.0	29.3	0.71	31.3	0.53	32.2	0.43		
50.0	31.6	0.45	33.7	0.43	34.3	0.43		
47.0	32.9	0.32	34.9	0.31	35.5	0.31		
	ブーム2 (%)	100						
	ブーム3 (%)	100						
	ブーム4 (%)	100						
	ブーム5 (%)	100						
	ブーム6 (%)	100						
	MODE	A,B						
	危険角度 [°]	46	46	46	46	63		
標準フック [ton]	4.5							
フック質量 kg	70							
巻掛本数 [本]	1							



























 ブーム	 ジブ 14.0m	 アウトリガ 6.3m	 作業範囲
--	---	--	---

 [m]	17.5								17.5									
	5		25		45		60		[°]	5		25		45		60		
	 (m)	 (ton)	 (m)	 (ton)	 (m)	 (ton)	 (m)	 (ton)		 (m)	 (ton)	 (m)	 (ton)	 (m)	 (ton)			
84.0	3.5	1.35	8.3	0.93	11.8	0.55	13.7	0.43	84.0	3.7	1.35	8.5	0.91	12.0	0.53	13.8	0.43	
80.0	5.9	1.35	10.4	0.86	13.6	0.52	15.2	0.42	80.0	6.1	1.35	10.5	0.83	13.8	0.51	15.3	0.42	
75.0	8.6	1.35	12.8	0.77	15.8	0.49	17.0	0.41	75.0	8.9	1.33	13.0	0.75	15.9	0.49	17.1	0.41	
70.0	11.2	1.20	15.1	0.70	17.7	0.47	18.7	0.41	70.0	11.5	1.18	15.3	0.69	17.8	0.47	18.7	0.41	
66.0	13.2	1.01	16.9	0.66	19.1	0.46	19.8	0.41	66.0	13.4	1.00	17.0	0.65	19.2	0.46	19.8	0.41	
63.0	14.7	0.92	18.1	0.63	20.1	0.45	20.6	0.41	63.0	14.8	0.92	18.2	0.62	20.2	0.45	20.6	0.41	
60.0	16.0	0.87	19.3	0.61	21.1	0.45			60.0	16.1	0.87	19.4	0.60	21.2	0.45			
55.0	18.2	0.81	21.1	0.58	22.5	0.45			55.0	18.3	0.81	21.2	0.57	22.6	0.44			
50.0	20.3	0.77	22.8	0.56	23.8	0.44			50.0	20.3	0.77	22.9	0.56	23.7	0.44			
46.0	21.7	0.74	24.0	0.55	24.7	0.42			46.0	21.7	0.74	24.0	0.55	24.6	0.42			
40.0	23.7	0.70	25.6	0.53					40.0	23.7	0.70	25.5	0.53					
35.0	25.2	0.66	26.6	0.53					35.0	25.2	0.66	26.6	0.53					
30.0	26.5	0.63	27.4	0.53					30.0	26.4	0.63	27.4	0.53					
26.0	27.3	0.61	27.9	0.53					26.0	27.3	0.61	27.9	0.53					
20.0	28.3	0.49							20.0	28.3	0.58							
15.0	28.9	0.42							15.0	28.8	0.57							
6.0	29.2	0.38							6.0	29.2	0.55							
	ブーム2 (%)	100								ブーム2 (%)	0							
	ブーム3 (%)	100								ブーム3 (%)	0							
	ブーム4 (%)	0								ブーム4 (%)	66							
	ブーム5 (%)	0								ブーム5 (%)	66							
	ブーム6 (%)	0								ブーム6 (%)	66							
	MODE	A								MODE	B							
 危険角度 [°]	5	25	45	62					[°]	5	25	45	62					
 標準フック [ton]	4.5								[ton]	4.5								
 フック質量 kg	70								kg	70								
 巻掛本数 [本]	1								[本]	1								











ブーム 	ジブ  14.0m	アウトリガ  6.3m	作業範囲 
--	---	--	---

 [m]	32.5							
	5		25		45		60	
 [°]								
	(m)	(ton)	(m)	(ton)	(m)	(ton)	(m)	(ton)
84.0	6.4	1.35	11.1	0.85	14.4	0.50	16.1	0.40
80.0	10.1	1.35	14.4	0.76	17.4	0.48	18.8	0.40
76.0	13.5	1.35	17.5	0.69	20.3	0.46	21.3	0.39
72.0	16.9	1.18	20.5	0.65	22.8	0.45	23.6	0.39
70.0	18.5	1.07	21.9	0.63	24.1	0.44	24.7	0.39
66.0	21.4	0.92	24.6	0.59	26.5	0.43	26.9	0.39
64.0	22.8	0.88	25.9	0.58	27.7	0.43	27.9	0.39
60.0	25.6	0.82	28.4	0.55	29.8	0.43		
55.0	28.6	0.57	31.3	0.51	32.2	0.43		
52.0	30.1	0.40	32.6	0.36	33.5	0.36		
51.0	30.7	0.34						
	ブーム2 (%)	100						
	ブーム3 (%)	100						
	ブーム4 (%)	100						
	ブーム5 (%)	100						
	ブーム6 (%)	100						
	MODE	A,B						
	危険角度 [°]	50	51	51	51	63		
標準フック [ton]	4.5							
フック質量 kg	70							
巻掛本数 [本]	1							





















 ブーム	 ジブ 14.0m	 アウトリガ 5.2m	 作業範囲
--	---	--	---

 [m]	17.5								17.5												
	5		25		45		60		[°]	5		25		45		60					
	 [°]	 (m)	 (ton)	 (m)	 (ton)	 (m)	 (ton)	 (m)		 (ton)	 (m)	 (ton)	 (m)	 (ton)	 (m)	 (ton)	 (m)	 (ton)			
84.0	3.5	1.35	8.3	0.93	11.8	0.55	13.7	0.43	84.0	3.7	1.35	8.5	0.91	12.0	0.53	13.8	0.43				
80.0	5.9	1.35	10.4	0.86	13.6	0.52	15.2	0.42	80.0	6.1	1.35	10.5	0.83	13.8	0.51	15.3	0.42				
75.0	8.6	1.35	12.8	0.77	15.8	0.49	17.0	0.41	75.0	8.9	1.33	13.0	0.75	15.9	0.49	17.1	0.41				
70.0	11.2	1.20	15.1	0.70	17.7	0.47	18.7	0.41	70.0	11.5	1.18	15.3	0.69	17.8	0.47	18.7	0.41				
66.0	13.2	1.01	16.9	0.66	19.1	0.46	19.8	0.41	66.0	13.4	1.00	17.0	0.65	19.2	0.46	19.8	0.41				
63.0	14.7	0.92	18.1	0.63	20.1	0.45	20.6	0.41	63.0	14.8	0.92	18.2	0.62	20.2	0.45	20.6	0.41				
60.0	16.0	0.87	19.3	0.61	21.1	0.45			60.0	16.1	0.87	19.4	0.60	21.2	0.45						
55.0	18.2	0.81	21.1	0.58	22.5	0.45			55.0	18.3	0.81	21.2	0.57	22.6	0.44						
50.0	20.3	0.77	22.8	0.56	23.8	0.44			50.0	20.3	0.77	22.9	0.56	23.7	0.44						
46.0	21.7	0.74	24.0	0.55	24.7	0.42			46.0	21.7	0.74	24.0	0.55	24.6	0.42						
40.0	23.7	0.57	25.5	0.53					40.0	23.7	0.70	25.5	0.53								
34.0	25.4	0.34	26.8	0.34					35.0	25.2	0.66	26.6	0.53								
33.0	25.6	0.31							34.0	25.5	0.65	26.8	0.53								
									33.0	25.7	0.64	26.9	0.53								
									30.0	26.4	0.63	27.4	0.53								
									26.0	27.3	0.61	27.9	0.53								
									20.0	28.3	0.58										
									15.0	28.8	0.57										
									6.0	29.2	0.55										
 ブーム2 (%)	100								ブーム2 (%)	0											
	 ブーム3 (%)	100								ブーム3 (%)	0										
		 ブーム4 (%)	0								ブーム4 (%)	66									
			 ブーム5 (%)	0								ブーム5 (%)	66								
				 ブーム6 (%)	0								ブーム6 (%)	66							
					MODE	A								MODE	B						
 危険角度	[°]	32	33	45	62	[°]	5	25	45	62											
 標準フック	[ton]	4.5								[ton]	4.5										
 フック質量	kg	70								kg	70										
 巻掛本数	[本]	1								[本]	1										

















 ブーム	 ジブ 14.0m	 アウトリガ 5.2m	 作業範囲
---	--	---	--

 [m]	32.5								
	5		25		45		60		
 [°]									
	 (m)	 (ton)	 (m)	 (ton)	 (m)	 (ton)	 (m)	 (ton)	
84.0	6.4	1.35	11.1	0.85	14.4	0.50	16.1	0.40	
80.0	10.1	1.35	14.4	0.76	17.4	0.48	18.8	0.40	
76.0	13.5	1.35	17.5	0.69	20.3	0.46	21.3	0.39	
72.0	16.9	1.18	20.5	0.65	22.8	0.45	23.6	0.39	
70.0	18.5	1.07	21.9	0.63	24.1	0.44	24.7	0.39	
66.0	21.4	0.92	24.6	0.59	26.5	0.43	26.9	0.39	
64.0	22.8	0.80	25.9	0.58	27.7	0.43	27.9	0.39	
62.0	24.3	0.58	27.1	0.52	28.7	0.43			
61.0	24.4	0.56							
	ブーム2 (%)	100							
	ブーム3 (%)	100							
	ブーム4 (%)	100							
	ブーム5 (%)	100							
	ブーム6 (%)	100							
	MODE	A,B							
	危険角度 [°]	60	61	61	61	63			
標準フック [ton]	4.5								
フック質量 kg	70								
巻掛本数 [本]	1								



 ブーム	 ジブ 14.0m	 アウトリガ 4.2m	 作業範囲
--	---	--	---







 [m]	17.5								17.5									
	5		25		45		60		[°]	5		25		45		60		
	 (m)	 (ton)	 (m)	 (ton)	 (m)	 (ton)	 (m)	 (ton)		 (m)	 (ton)	 (m)	 (ton)	 (m)	 (ton)			
84.0	3.5	1.35	8.3	0.93	11.8	0.55	13.7	0.43	84.0	3.7	1.35	8.5	0.91	12.0	0.53	13.8	0.43	
80.0	5.9	1.35	10.4	0.86	13.6	0.52	15.2	0.42	80.0	6.1	1.35	10.5	0.83	13.8	0.51	15.3	0.42	
75.0	8.6	1.35	12.8	0.77	15.8	0.49	17.0	0.41	75.0	8.9	1.33	13.0	0.75	15.9	0.49	17.1	0.41	
70.0	11.2	1.20	15.1	0.70	17.7	0.47	18.7	0.41	70.0	11.5	1.18	15.3	0.69	17.8	0.47	18.7	0.41	
66.0	13.2	1.01	16.9	0.66	19.1	0.46	19.8	0.41	66.0	13.4	1.00	17.0	0.65	19.2	0.46	19.8	0.41	
63.0	14.7	0.92	18.1	0.63	20.1	0.45	20.6	0.41	63.0	14.8	0.92	18.2	0.62	20.2	0.45	20.6	0.41	
60.0	16.0	0.87	19.3	0.61	21.1	0.45			60.0	16.1	0.87	19.4	0.60	21.2	0.45			
55.0	18.2	0.81	21.1	0.58	22.5	0.45			55.0	18.3	0.81	21.2	0.57	22.6	0.44			
50.0	20.2	0.56	22.8	0.47	23.8	0.44			50.0	20.3	0.77	22.9	0.56	23.7	0.44			
47.0	21.2	0.39	23.6	0.34	24.5	0.34			47.0	21.4	0.75	23.7	0.55	24.4	0.43			
46.0	21.6	0.34							46.0	21.7	0.74	24.0	0.55	24.6	0.42			
									40.0	23.7	0.70	25.5	0.53					
									35.0	25.2	0.66	26.6	0.53					
									30.0	26.4	0.55	27.4	0.53					
									26.0	27.3	0.47	27.9	0.47					
									20.0	28.3	0.39							
									15.0	28.8	0.35							
									6.0	29.2	0.32							
	ブーム2 (%)	100								ブーム2 (%)	0							
	ブーム3 (%)	100								ブーム3 (%)	0							
	ブーム4 (%)	0								ブーム4 (%)	66							
	ブーム5 (%)	0								ブーム5 (%)	66							
	ブーム6 (%)	0								ブーム6 (%)	66							
	MODE	A								MODE	B							
 危険角度	[°]	45	46	46	62	[°]	5	25	45	62								
 標準フック	[ton]	4.5								[ton]	4.5							
 フック質量	kg	70								kg	70							
 巻掛本数	[本]	1								[本]	1							

ブーム 	ジブ  14.0m	アウトリガ  4.2m	作業範囲 
--	---	--	---

 [m]	32.5							
	5		25		45		60	
 [°]								
 [°]	 (m)	 (ton)	 (m)	 (ton)	 (m)	 (ton)	 (m)	 (ton)
	84.0	6.4	1.35	11.1	0.85	14.4	0.50	16.1
80.0	10.1	1.35	14.4	0.76	17.4	0.48	18.8	0.40
76.0	13.5	1.35	17.5	0.69	20.3	0.46	21.3	0.39
72.0	16.9	1.18	20.5	0.65	22.8	0.45	23.6	0.39
70.0	18.5	0.97	21.9	0.63	24.1	0.44	24.7	0.39
	ブーム2 (%)	100						
	ブーム3 (%)	100						
	ブーム4 (%)	100						
	ブーム5 (%)	100						
	ブーム6 (%)	100						
	MODE	A,B						
 [°]	69		69		69		69	
 [ton]	4.5							
 kg	70							
 [本]	1							









ブーム 	ジブ	アウトリガ 	作業範囲
--	----	--	------

作業範囲		7.5		12.5				17.5				22.5			
		↑	⏻	↑	⏻	↑	⏻	↑	⏻	↑	⏻	↑	⏻	↑	⏻
 [m]	2.6	13.00	8.20	12.00	6.50	12.00	6.50	8.00	6.50	8.00	6.50				
	3.0	13.00	8.20	12.00	6.50	12.00	6.50	8.00	6.50	8.00	6.50	6.50	5.00	6.50	5.00
	3.5	11.50	5.40	11.00	5.20	11.00	5.20	8.00	5.20	8.00	5.20	6.50	5.00	6.50	5.00
	4.0	10.00	4.20	9.60	4.00	9.60	4.00	8.00	4.00	8.00	4.00	6.50	5.00	6.50	5.00
	4.5	8.50	3.20	8.10	3.20	8.10	3.20	7.70	3.10	7.70	3.10	6.50	3.80	6.50	3.80
	5.0	7.00	2.30	6.80	2.50	6.80	2.50	6.80	2.40	6.80	2.40	6.50	2.90	6.50	2.90
	5.5			5.70	1.90	5.70	1.90	5.80	1.80	5.80	1.80	5.75	2.25	5.75	2.25
	6.0			4.60	1.30	4.60	1.30	4.80	1.20	4.80	1.20	4.85	1.75	4.85	1.75
	6.5			3.65	0.80	3.65	0.80	3.95	0.75	3.95	0.75	4.15	1.30	4.15	1.30
	7.0			2.95	0.50	2.95	0.50	3.10	0.50	3.10	0.50	3.60	0.95	3.60	0.95
	8.0			2.05		2.05		1.80		1.80		2.65	0.50	2.65	0.50
	9.0			1.40		1.40		1.10		1.10		1.80		1.80	
	10.0			0.80		0.80		0.70		0.70		1.20		1.20	
11.0							0.50		0.50		0.80		0.80		
12.0											0.60		0.60		
	ブーム2 (%)	0		50		0		100		0		100		0	
	ブーム3 (%)	0		50		0		100		0		100		0	
	ブーム4 (%)	0		0		33		0		66		33		100	
	ブーム5 (%)	0		0		33		0		66		33		100	
	ブーム6 (%)	0		0		33		0		66		33		100	
	MODE	A,B		A		B		A		B		A		B	
 危険角度	[°]	-	-	-	44	-	44	42	59	42	59	51	63	51	63
 標準フック	[ton]	22													
 フック質量	[kg]	225													
 巻掛本数	[本]	4													

(単位 : ton)

ブーム 	ジブ	アウトリガ  2km/h未満	作業範囲
--	----	---	------

作業範囲		7.5		12.5				17.5				22.5			
		↑	⌚	↑	⌚	↑	⌚	↑	⌚	↑	⌚	↑	⌚	↑	⌚
 [m]	2.6	9.50	6.00	9.50	5.50	9.50	5.50	7.00	5.50	7.00	5.50				
	3.0	9.50	6.00	9.50	5.50	9.50	5.50	7.00	5.50	7.00	5.50	6.00	4.50	6.00	4.50
	3.5	8.50	4.50	8.60	4.40	8.60	4.40	7.00	4.40	7.00	4.40	6.00	4.50	6.00	4.50
	4.0	7.50	3.55	7.50	3.55	7.50	3.55	7.00	3.55	7.00	3.55	6.00	3.90	6.00	3.90
	4.5	6.60	2.85	6.60	2.85	6.60	2.85	6.40	2.85	6.40	2.85	6.00	3.40	6.00	3.40
	5.0	5.80	2.30	5.80	2.25	5.80	2.25	5.80	2.25	5.80	2.25	5.60	2.90	5.60	2.90
	5.5			5.00	1.75	5.00	1.75	5.20	1.75	5.20	1.75	5.20	2.25	5.20	2.25
	6.0			4.20	1.30	4.20	1.30	4.60	1.20	4.60	1.20	4.70	1.75	4.70	1.75
	6.5			3.55	0.80	3.55	0.80	3.90	0.75	3.90	0.75	4.15	1.30	4.15	1.30
	7.0			2.80		2.80		3.10		3.10		3.60	0.95	3.60	0.95
	8.0			1.95		1.95		1.80		1.80		2.65		2.65	
	9.0			1.40		1.40		1.10		1.10		1.80		1.80	
	10.0			0.80		0.80		0.70		0.70		1.20		1.20	
11.0							0.50		0.50		0.80		0.80		
12.0											0.60		0.60		
	ブーム2 (%)	0		50		0		100		0		100		0	
	ブーム3 (%)	0		50		0		100		0		100		0	
	ブーム4 (%)	0		0		33		0		66		33		100	
	ブーム5 (%)	0		0		33		0		66		33		100	
	ブーム6 (%)	0		0		33		0		66		33		100	
	MODE	A,B		A		B		A		B		A		B	
 危険角度	[°]	-	-	-	48	-	48	42	61	42	61	51	66	51	66
 標準フック	[ton]	22													
 フック質量	[kg]	225													
 巻掛本数	[本]	4													

(単位 : ton)

# ■最小通路軌跡図

● 60°

2輪ステアリングで右折する場合

4輪ステアリングで右折する場合(構内移動)

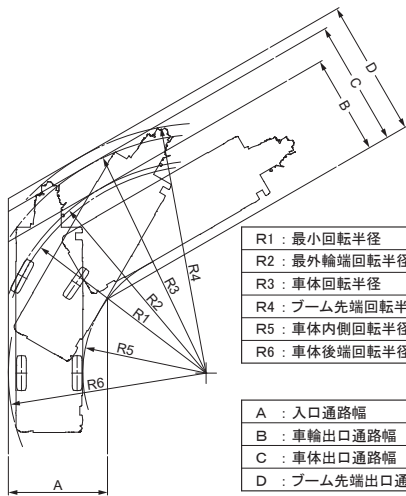

R1 : 最小回転半径	8.10m
R2 : 最外輪端回転半径	8.29m
R3 : 車体回転半径	9.31m
R4 : ブーム先端回転半径	9.75m
R5 : 車体内側回転半径	4.81m
R6 : 車体後端回転半径	7.71m

A : 入口通路幅	3.87m
B : 車輪出口通路幅	3.87m
C : 車体出口通路幅	4.89m
D : ブーム先端出口通路幅	5.33m

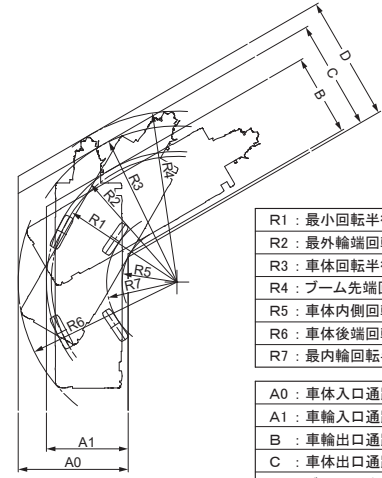

R1 : 最小回転半径	4.90m
R2 : 最外輪端回転半径	5.09m
R3 : 車体回転半径	6.09m
R4 : ブーム先端回転半径	6.67m
R5 : 車体内側回転半径	2.14m
R6 : 車体後端回転半径	6.19m
R7 : 最内輪端回転半径	2.75m

A0 : 車体入口通路幅	4.29m
A1 : 車輪入口通路幅	3.19m
B : 車輪出口通路幅	3.19m
C : 車体出口通路幅	4.29m
D : ブーム先端出口通路幅	4.87m

● 90°

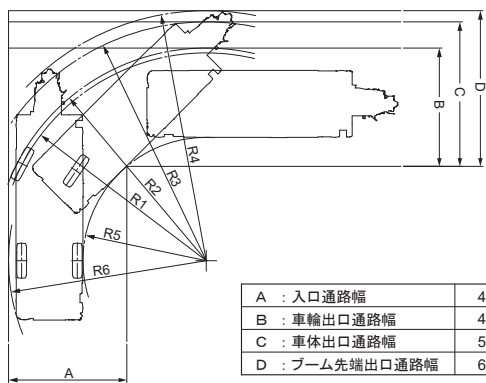

A : 入口通路幅	4.62m
B : 車輪出口通路幅	4.62m
C : 車体出口通路幅	5.64m
D : ブーム先端出口通路幅	6.07m

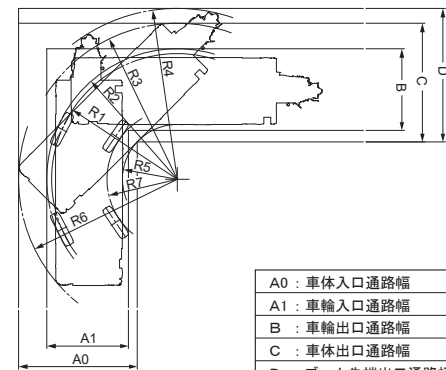

A0 : 車体入口通路幅	4.63m
A1 : 車輪入口通路幅	3.19m
B : 車輪出口通路幅	3.19m
C : 車体出口通路幅	4.63m
D : ブーム先端出口通路幅	5.21m

● 120°

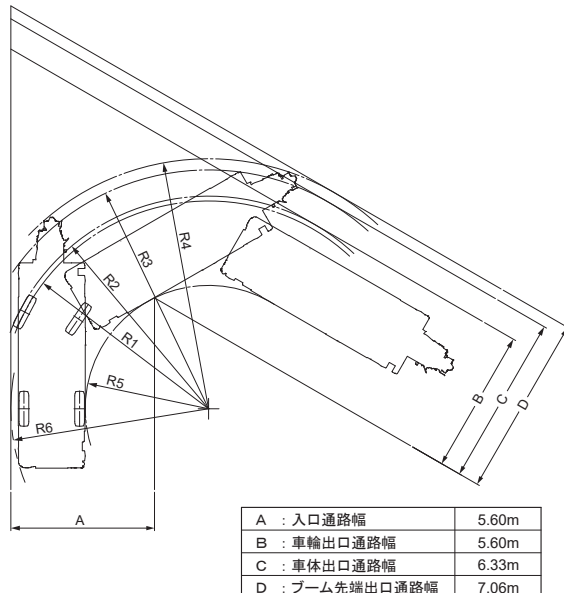

A : 入口通路幅	5.60m
B : 車輪出口通路幅	5.60m
C : 車体出口通路幅	6.33m
D : ブーム先端出口通路幅	7.06m

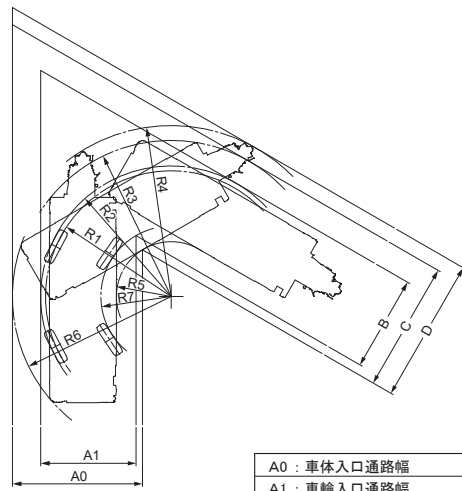

A0 : 車体入口通路幅	5.07m
A1 : 車輪入口通路幅	3.72m
B : 車輪出口通路幅	3.72m
C : 車体出口通路幅	5.07m
D : ブーム先端出口通路幅	5.65m

■ 全体図

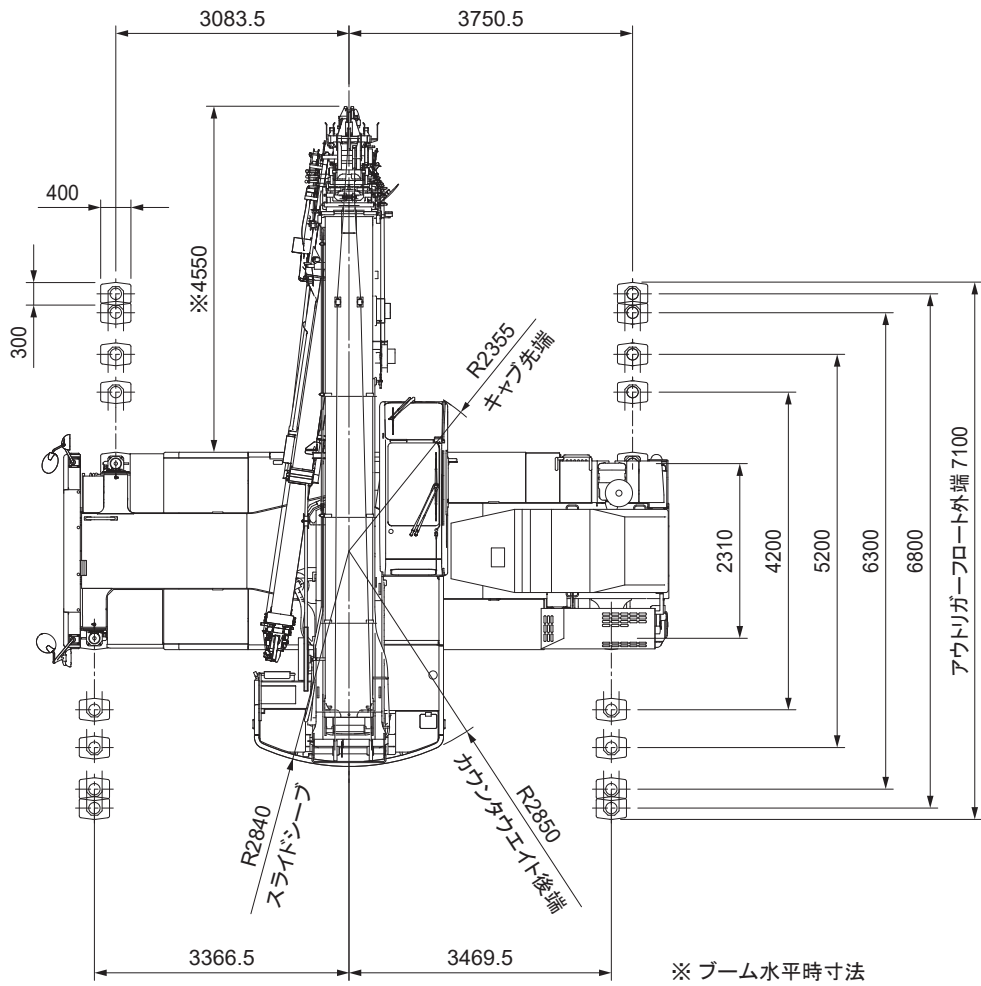
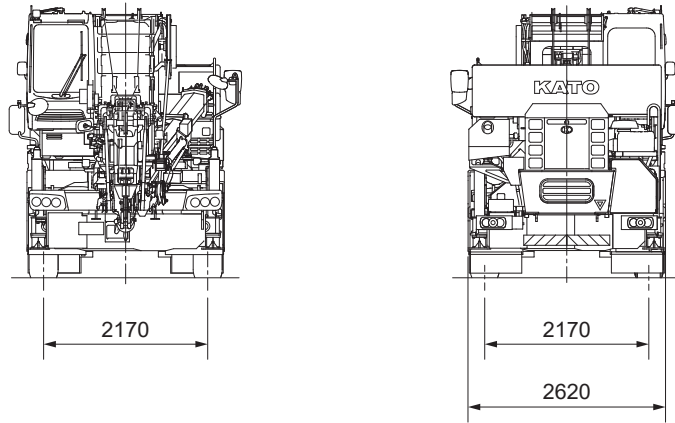

縮尺:  $\frac{1}{100}$  単位 (mm)

■全体図

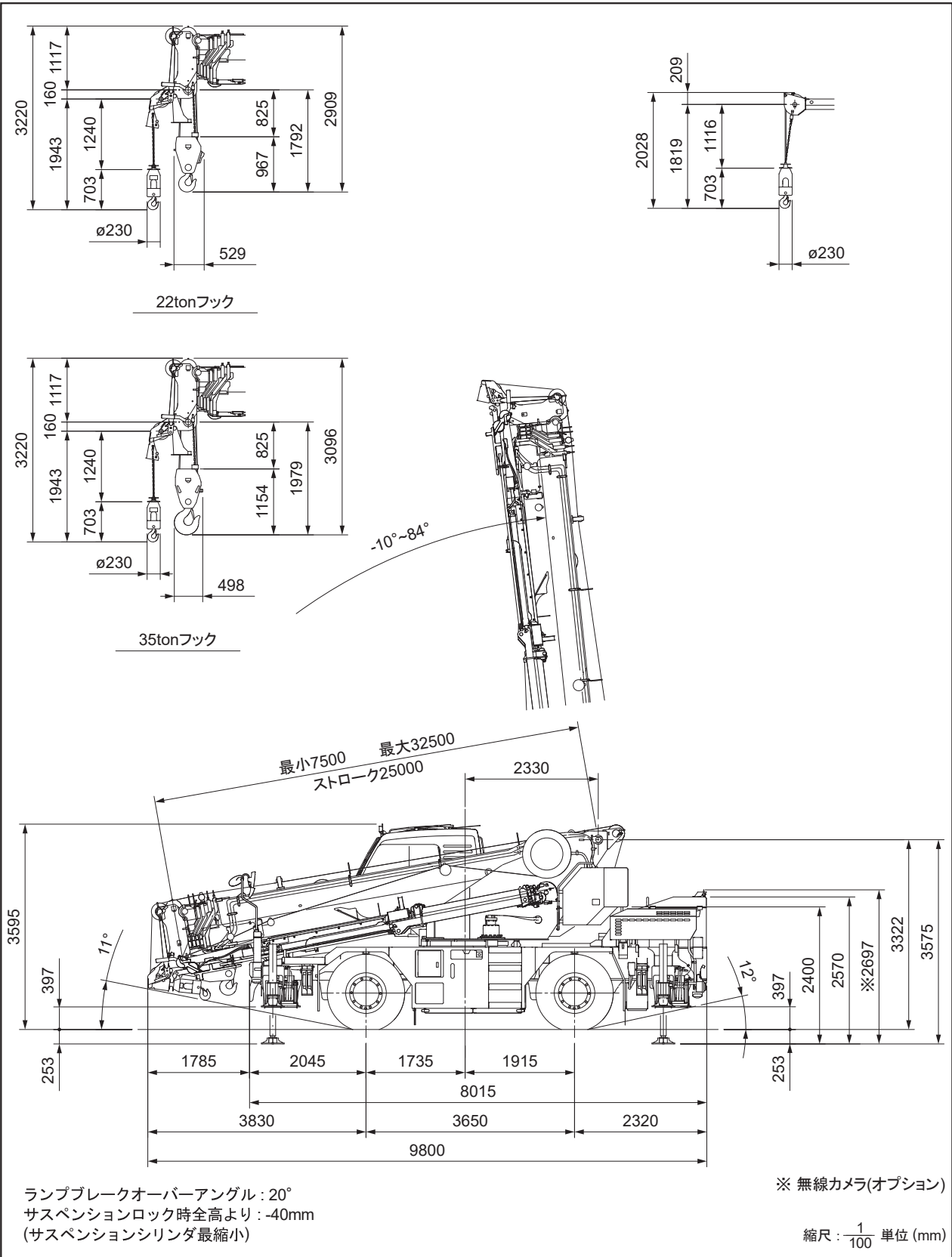

※本カタログに記載されております性能ならびに仕様は、改良などによりお届けいたします製品と異なる場合がありますので、あらかじめご了承ください。

お問い合わせは…

**KATO** 株式会社 **加藤製作所**

本 社 / 〒140-0011 東京都品川区東大井1丁目9番37号

☎ 03 (3458) 1111 番 (大代表)

ホームページアドレス <http://www.kato-works.co.jp>

**C05741**

12.2021-2000 (TI) 1